

## GAS DYNAMIC COUPLING OF TWO VALVELESS PULSED COMBUSTORS FOR PRESSURE-GAIN COMBUSTION CHAMBERS

التزاوج الديناميكي الغازي لحارقين من النوع النبضي لغرفة احتراق ذات ضغط مكتسب

E.M. Marzouk, S. G. Ahmed, M.F. El-Erian and A. I. Abdelfattah  
Mechanical Engineering Department, Faculty of Engineering,  
Alexandria University, Alexandria, Egypt.

### ملخص:

يقدم البحث توصيفا لأداء غرفة الاحتراق ذات الضغط المكتسب من الاحتراق باستعمال الحارق النبضي لاستخدامها في التربينات الغازية لتحسين أداء المحرك، وذلك من بين استخدامات أخرى عديدة للحارق النبضي. ويقدم البحث دراسة تحليلية بارامترية ثيرموديناميكية لايضاح كيفية تحسين أداء الحارق النبضي من زيادة في قوة الدفع وزيادة في الكفاءة الحرارية التحويلية نتيجة انضغاط الشحنة في حيز احتراق الحارق قبل بدء الإشتعال. وتم هذا على نموذج مثالي مبسط يحاكي احتراق الشحنة تحت حجم ثابت ومثلاً لتأثير حارقين كل منهما على الآخر عند تزاوجهما غازياً في غرفة احتراق ذات ضغط مكتسب. وتم إجراء برنامج للتجارب العملية على حارق نبضي واحد وكذا على حارقين نبضيين للتشغيل الترافقي المزودج بينهما عند إتصالهما معا عند فتحات طرد الغازات من الناقتين. وتهدف التجارب إلى الوصول إلى أفضل أداء متمثلاً في أقصى قوة دفع وأقصى معدل إستهلاك للوقود. وقد بين البحث نجاح طريقة التزاوج في تثبيت التشغيل النبضي لكلا الحارقين في وجه معاكس للآخر ومضاعفة الذبذبة داخل غرفة التزاوج مما يسهل من إمكانية إخماد الصوت. كما تحقق عملياً فائدة انضغاط الشحنة في الحارق قبل الإشتعال على أداء الحارق النبضي في زيادة قوة الدفع عند نفس معدل استهلاك الوقود. وذلك على الرغم من تدني مستوى الاداء الكلي بالمقارنة للأداء النوعي لحارق واحد مما يتطلب استكمال دراسة غرفة الاحتراق ذات الضغط المكتسب.

### ABSTRACT

The function and preference of pressure-gain pulsed combustors are described as an important application amongst other diverse potential uses of pulsed combustors. A thermodynamic parametric analysis is given to establish the advantages of charge precompression in a constant volume combustion model representing two gas dynamically coupled pulsed combustors for a pressure-gain combustion chamber. Test results from the single and the two coupled valveless pulsed combustors, are presented. It is shown that the two combustors can be successfully locked gas dynamically in antiphase relationship operation. The potential for noise suppression due to coupling is discussed and demonstrated. Though the specific performance

due to coupling, based on maximum specific thrust and maximum specific fuel flow rate, is deteriorated. The effect on performance of precompression of the charge due to coupling is realised with significant increase in total specific thrust at the same fuel flow consumption.

Keywords: Pulsed combustors, gas dynamic coupling, performance, noise.

### NOMENCLATURE

$A$	= Cross sectional area, $m^2$
$C_d$	= Flow coefficient applicable to outflow
$C_p$	= Specific heat at constant pressure, $kJ/kg. K$
$C_v$	= Specific heat at constant volume, $kJ/kg.K$
$f$	= Fuel air ratio
$H$	= Lower calorific value of fuel, $kJ/kg$
$k$	= Specific heat ratio
$\bar{m}$	= Combustor time averaged outflow ratio, $kg/sec.$
$m_f$	= Fuel flow rate, $kg/sec.$
$n$	= Number of outflow pulses per cycle.
$P$	= Total pressure, $kPa$
$\bar{q}$	= Time averaged heat loss rate through structure, $kJ/sec.$
$R$	= Gas constant, $kJ/kg. K$
$t, t'$	= Time and non dimensional times, $sec.$
$T$	= Total temperature, $K$
$u$	= Flow velocity, $m/sec$
$x, x'$	= Space and non dimensional space variables. , $m$
$\delta P$	= Pressure gain ( $P_8 - P_{AMB}$ ), $model, kPa$
$\delta t_i$	= Duration of $i$ th outflow period, $sec.$
$\delta t_{cycle}$	= Duration of combustor cycle, $sec.$
$\Delta$	= Pressure ratio for constant volume combustion, $model$
$\theta$	= $kg$ recirculated exhaust gas per $kg$ combustion air
$\Phi$	= $kg$ dilution air per $kg$ combustion air
$\rho$	= Flow density, $kg/m^3$
$\bar{\tau}$	= Time averaged thrust, $N$
$\eta$	= Thermal efficiency
$\eta_c$	= Combustion efficiency

### Subscripts

1,2,3 = State points (Figure (2))

AMB = Ambient

OUT = Outflow

P,R = Precompression and Recirculation (Figure (2)).

## INTRODUCTION

The incentives for using pulsating combustion preferentially relate to a self induced, vigorous, stirring action within the combustion space and also a potential for achieving a pressure gain, or on the other hand, the effects can be used to pump the products of combustion through heat exchangers, boilers, .etc. Among other advantages that have led to active research in this area in the last few decades, are higher thermal efficiency, higher heat transfer rates, higher combustion intensities and reduced pollutant emissions [1,2]

The function of a pressure-gain combustor (e.g. for a gas turbine) is to generate a gain in stagnation pressure across the combustion chamber in addition to providing the temperature rise normally associated with steady flow combustors. The steady flow combustors are usually called constant pressure combustors. This is a misnomer, since in reality they suffer stagnation pressure drop across air inlet and products outlet. In addition to the total pressure loss due to mixing and frictional effects, there is the fundamental heating loss resulting from the need of the gas to accelerate as its density decreases with heating to maintain continuity. In a pulsed combustor, which is the heart of a pressure gain chamber, the pressure exchange associated with the nonsteady operation, the high frequency and broad pulse width enable the exhaust gases to drive into and maintain a higher than inlet pressure at the discharge end of the chamber [3,4,5,6,7]. Fig. (1) shows a schematic diagram of an elementary, valveless, pulsed combustion pressure-gain combustor for gas turbine [5]. The thrust augmenter flow rectifier, on the left side of the figure, serves to catch and redirect rearwards, backflow emerging from pulsed combustor inlet and also entrain, by ejection like action, a secondary air flow from the air inlet region. The first proposals for a valveless pulsed combustor with no moving parts and capable of operation at high volumetric loadings appear to be due to [8,9]. The rotary inlet valved units, e.g. [10] or flap valved units, e.g. [8], have the common disadvantage of provision of a major constant speed rotary parts or highly stressed parts that affect the integrity and reliability of the unit.

Other applications, of current interest for pulsed combustors include space and water heating [11,12], propulsion applications [13, 14], high intensity boiler [15] and drying applications [16,17], .etc.

The disadvantages of a pulsed pressure gain combustors relate mainly to problems of noise and the lack of the combustor to significantly precompress the charge before the onset of combustion. This insignificant precompression limits the pressure gain potential of the combustor [5]. It is possible, at least in principle, to overcome these problems if two valveless pulsed combustors can be made to operate mutually in antiphase.

The present work shows quantitative thermodynamic parametric model results relating to benefits of precompression resulting from gas dynamic coupling of two pulsed combustors. Correlation of pressure gain to the thrust produced, is also reported. The mode of operating of the two coupled combustors at the exit plenum is introduced based on simplified idealized time dependent of the one dimension flow. Experimental results obtained from tests carried out on the two coupled pulsed combustors are also reported.

### Thermodynamic Model For Precompression Effect:

It is possible to produce a pressure gain during combustion by confining the burning process. For example, the Otto cycle piston engine draws in air from ambient, burns the mixture in fixed volume, producing significant pressure rise. The subsequent piston motion extracts useful work from gas expansion. This is to be different from the gas turbine case where the combustion occurs at nearly constant pressure, without producing useful work during gas expansion associated with the heat addition. Downstream of the combustor, energy is extracted from gas expansion in engine rotor, but the unrestrained expansion in the combustor produces an appreciable loss in thermodynamic availability. This has made the motivation for novel compound engine cycles, typically using piston engine as topping cycle for a turbine. The piston engine serves to capture the expansion work from combustion process and the turbine extracts additional work from exhaust stream. However, the complexity of combined turbine and piston engines have prevented their widespread acceptance. A different approach to capture the benefits of confined combustion in gas turbines is to use pulse combustor. A schematic of such pressure generating combustion chamber using pulse combustor is shown in Figure (1). The oscillating gas motion is used to confine the combustion process. With correct timing of the unsteady gas flows, the fluid motion is, in effect, analogous to piston and valve assembly in piston engine, yet without the complexity of mechanical parts. The benefits of precompression results from gas dynamic coupling of two pulsed combustors on pressure gain potential may be analysed by using a Lenoir cycle piston engine to generate pressure gain.

Figure (2) shows the model used to evaluate the effect on pressure gain obtained from pulsed combustor from precompression of the charge before the onset of combustion. The flow diagram Fig. (2a), presents a two stroke piston engine working on ideal constant volume combustion scheme during the outward suction stroke. Gases expand after combustion to the end of the stroke where it expelled during exhaust stroke against back pressure. The charge in and discharge out of the cylinder are idealized with no pressure drops. The net work extracted is used to compress the excess air, which is mixed with exhaust gases for a certain desired maximum outlet combustor temperature at

higher outlet pressure than inlet air. Fig. (2a) also shows the flow diagrams when allowing for precompression of fresh charge and for recirculation of exhaust combustion gases to inlet fresh charge. The combustor air inlet (or piston engine inlet) state points 2, 2P and 2R are at ambient pressure or at compressor delivery pressure of a gas turbine for the cases with no precompression and recirculation, with precompression and with exhaust gas recirculation, respectively. The combustor exhaust gas outlet (or engine outlet) state points 5, 5P and 5R are at higher pressure than inlet and at maximum outlet combustor temperature. State point 3 represents the outlet condition of a steady nominally constant pressure combustion chamber of a gas turbine. Fig. (2b) shows the temperature-entropy diagram for the cycle model for the case with no precompression. No attempt to add the cycle model for precompression and exhaust recirculation to avoid complexities and distract attention for concise presentation.

The model is not intended to represent typically the two coupled pulsed combustors. However, from function point of view, it performs the same operations occurring within twin coupled pressure gain combustors. The virtue of the model relates to simplicity of analysis when compared to the complex unsteady flow processes involved in the pulsed combustors.

Assume stoichiometric fuel air ratio of combustion mixture,  $f = 0.066$ . The working fluid is assumed to have properties of air and the calorific value of fuel is equal to 42000 kJ/kg. Assume expansion and compression processes are isentropic, and stagnation temperature ratio of combustor outlet to air inlet is 2.5 ( $T_3/T_2$ ). Equating the work extracted from piston engine and that required to compress the dilution air, and application of energy equation to mixing different streams, results in the following parametric equations for the case of no precompression of the fresh charge.

$$T_3 C_p (\Phi + \Delta^{1/k}) = T_2 (\Phi C_p + R(\Delta + k - 1)/(k - 1)) \quad (1)$$

Where;

$$\Phi = (f H / C_p (T_3 - T_2)) - 1 \quad (2)$$

$$\Delta = (f H / C_v T_2) - 1 \quad (3)$$

The pressure gain ratio is obtained

$$(p_3/p_{AMB}) = (T_3/T_{AMB})^{k/k-1} \quad (4)$$

Similar procedures for case with precompression and with recirculation of exhaust gases are also carried out. The relative (not the absolute) efficiency of precompression on the thrust produced and on thermal efficiency are shown in Fig. (3) and Fig. (4), respectively. The performance of the device as a thrust generator is of essential interest, discussed in the

next section, as the pressure gain from the pulse combustor unit Fig. (1) is related to thrust. However, the effectiveness with which fuel is converted into kinetic energy, which is indicated as thermal efficiency, is also reported.  $(\tau_{\text{with}}/\tau_{\text{without}})$  is the ratio of thrust generated with precompression to that without precompression, both based on certain exhaust gas recirculation ratio.  $(\eta_{\text{with}}/\eta_{\text{without}})$  is the thermal efficiency with precompression to that without precompression, both based on a certain exhaust recirculation ratio. Typical value of  $q$  for valveless pulsed combustors appears to exceed 50% based on the the first author experience and from [18].

Figure (3) and Fig. (4) imply that significant increases in thrust and thermal efficiency are obtainable even with moderate precompression of the fresh charge. Hence, provided that the two pulsed combustors can be locked in antiphase operation, the energy exchange associated with one combustor may be used beneficially to precompress the charge of the other combustor.

### Correlation of Thrust to Pressure Gain

In the next sections of experimental results of combustors, it is aimed at maximizing the static thrust produced and minimizing the specific fuel consumption. Correlation of thrust measurements, fuel flow rate and temperature measurements in a combustor, such as shown in Fig. (1), permits the pressure gain to be estimated. The combustor testing is made in laboratory, self aspirating under ambient pressure. This results in outflow gases expelled at static pressure equal to ambient pressure. Thus, the resulting stagnation pressure gain is the increase above ambient intake pressure of the outflow from combustor. In the following analysis, it is assumed that the pressure during outflow is uniform and outflow occurs during a fraction  $y$  of the cycle time  $\delta t_{\text{cycle}}$  Fig. (5). It is assumed also that the relationship between velocity and pressure in combustor outflow is incompressible (i.e small pressure gain and relatively low gas Mach number). From Fig. (5), the governing equation of the system may be written as:

$$\Psi = \sum_{i=1}^n \delta t_i / \delta t_{\text{cycle}} \quad (5)$$

The energy equation applied to the whole combustor unit Figure (1):

$$\bar{m} C_p (T_{\text{OUT}} - T_{\text{AMB}}) + \bar{q} = \dot{m}_f \eta_c H \quad (6)$$

The continuity equation is written as

$$\bar{m} = C_d \rho_{\text{OUT}} - A_{\text{OUT}} u \quad (7)$$

The momentum equation for subcritical outflow as assumed;

$$\bar{\tau} = C_d \Psi \rho_{OUT} A_{OUT} u^2 \quad (8)$$

and Bernoulli's equation to combustor outflow;

$$\delta P = (P_{OUT} - P_{AMB}) = \rho_{OUT} u^2 / 2 \quad (9)$$

Algebraic manipulation of equations (6) to (9) lead to:

$$\delta P / P_{AMB} = \frac{T_{OUT} \bar{\tau}^{-2}}{2R} [C_p (1 - T_{AMB} / T_{OUT}) / (m_f \eta_c H - q)]^2 \quad (10)$$

When all variables on the right hand side of equation (10) except  $\bar{\tau}$  do not vary, it can be seen that the pressure gain ( $\delta P / P_{AMB}$ ) is directly proportional to square of average thrust.

In cases in which  $\bar{q}$  tends to zero and  $\eta_c$  and  $T_{OUT}$  are constants, it can be seen that

$$\delta P / P_{AMB} = C (\bar{\tau}^{-2} / m_f^2) \quad (11)$$

where C is a constant

#### Test Apparatus:

A single, highly rated, propane fuelled, valveless pulsed combustor with internal proportions of the unit as per SNECMA/Lockwood design [5,19], is used in the present work. Figure (6) shows the constructional details of the present experimentally optimized pulsed combustor. The combustion space internal diameter Fig. (6), is increased to 80 mm in relation to SNECMA design. This is aimed at reducing frictional effects, irreversibilities, etc due to increased flow Reynolds number in the fully developed version pressure gain combustor such as shown in Fig. (1).

Provided two pulsed combustors are coupled to operate in antiphase, the potential also exists for obtaining a measure of wave cancellation and noise control. Two typical pulsed combustors of that shown in Fig. (6) are used for coupling experiments.

Figure (7) shows a schematic diagram of the configuration used for gas dynamic coupling. It illustrates the system with a common exhaust plenum for the tail pipe ends, two unsteady flow ejectors to cope with the tail pipe exists backflows [20,21] and an inlet pipe. Fuel flow rate is measured by calibrated choked nozzle meter. Two calibrated thrust meters of the free displacement type, are used for static thrust measurements at the inlets and exists of the combustors. Pressure-time traces in the two combustion spaces of the

combustors are recorded by two calibrated piezoquartz water cooled pressure transducers. The average pressure in the plenum is measured by a water manometer. The noise level from the combustors is received by a condenser microphone and recorded on a magnetic tape. The output of the recorder is fed to spectrum analyzer for audio spectrum up to 10,000 Hz. Full dimensional details of the test rig is available in Ref.[22].

The design of the proposed coupling system, was based on idealized simplified analysis of the method of characteristics to solve the one dimensional time dependent flow equations [22]. The (x-t) diagram of the coupling system, shown in Fig. (8), suggests how the coupling configuration results in some degree of precompression of the fresh charge to the combustors working in antiphase. The diagram also gives approximate lengths for both inlet air pipe, and the ejector augmenters.

## RESULTS AND DISCUSSION

The optimization test program for a single combustor with 80 mm internal diameter combustion space was carried out. It included variations of the combustor inlet pipe and tail pipe lengths, inlet pipe configuration, tail pipe throat diameter and fuel injection nozzles configuration. The geometric variations are aimed at improving the breathing capacity of the combustor and at improving the fuel distribution and enhancing the mixing between fuel, air and residual combustion gases. This improvement leads, in effect, to maximize the thrust produced and to have the least specific fuel consumption. Figure (9) shows the performance of the present optimized combustor compared to that of SNECMA [5, 19].

Series of tests, using a single combustor, to optimize the unsteady ejector for the coupling system, Fig. (7), were carried out in ambient atmosphere. The energy exchange process in the unsteady ejector here is quite unlike that in the steady flow counterpart which utilizes viscous and turbulent mixing to induce the, secondary flow. By comparison the unsteady ejector is based on wave motion, which become reversible under ideal conditions and, therefore, appears to offer high efficiency. Hence, thrust augmentation ratio of 1.65, is obtained for quite compact optimized ejector [22].

The arrangement for gas dynamic coupling at tail pipe exists of the combustors, Fig. (7), has been tested and has shown to result of locked in antiphase operation of the two combustors. This is illustrated in Fig. (10), which shows the combustion space pressure traces when combustors "A" and "B" are coupled. Figure (10) also shows the corresponding traces for dual combustors with the coupling system removed. It is worth reporting that during the dual operation of uncoupled combustors, an acoustical beating was heard clearly as the combustors gradually changed from phased to antiphased operation and then to phased. This suggests that there is no coupling mechanism to lock the combustors in certain phase relationship.



The acoustical measurement analysis of the coupled combustors, the dual operation of uncoupled combustors and of a single combustor are shown in Figure (11). The figure suggests the presence of a strong signal at the fundamental frequency of the combustor, in this case 190 Hz. Strong harmonic contributions are also, as expected, due to the non sinusoidal nature of the fundamental signal at both combustor inlet and tail pipe exists. The figure indicates that the most important contributions are due to fundamental frequency of 190, 380, 570,...etc., in descending order. The potential for obtaining a measure of wave cancellation from coupling operation at tail pipe exits is clear to reduce the sound level by nearly 20 db, compared to dual operation. It is expected that more effective muffling would be through energy reduction of the combustor inlet, bare and open in this case, in the fully developed shrouded version for gas turbine pressure gain combustor such as that from Fig. (1). It is also expected that the presence of the turbine, because it extracts from combustor outflow, tend to ameliorate combustors generated noise. This phenomena is well known in turbo supercharged piston engines. The fundamental difficulty that makes the use of sound absorbent (porous) media, for example in the turbine exhaust duct lining, quite ineffective at the fundamental low frequency (190 Hz) of a single combustors, is also alleviated by coupling.

The specific performance per unit combustion space area, Fig. (12) and Fig. (13), for the coupled combustors, is significantly deteriorated compared to the single combustor with the unsteady ejector in ambient atmosphere with no plenum chamber. This seems to be attributed to the lower than atmospheric pressure encountered in the exhaust plenum, which dragged the combustors into air pumping. This would be overcome in the fully developed version of the gas turbine pressure-gain combustors such as in Fig. (1), where the flow rectifier is used to catch and redirects the backflow from the combustor inlet forcing it with the secondary air to the exhaust plenum. It is worth mentioning at this stage of development reference to equation (4), that the secondary flow ducts in Fig. (1) would be replaced by axisymmetric shroud around the combustor and the two combustors placed in an inlet plenum cell ahead of the exhaust plenum. This is not only cool the combustor as flame tube but also reduce the average heat loss from the combustor structure.

However, the anticipated thrust gain from precompression effect due to coupling the two combustors is realized with reference to Fig. (12) and Fig. (13). This is illustrated by the increase in specific thrust of the coupled units measured at inlet ends of the combustors Fig. (12). Also the increased thrust level at the tail ends of the coupled version compared to the single combustor when operated with the exit plenum and blocking the outlets for the other combustor Fig. (13).

## CONCLUSIONS

1. The thermodynamic constant volume combustion model representing the coupled pulsed combustors for pressure-gain combustion chamber, predicts significant beneficial effects due to precompression of the charge before ignition on thrust produced and thermal efficiency even at moderate precompression ratio.
2. Correlation of thrust to pressure-gain is derived from which the experimental results based on thrust can be used to estimate the combustor pressure-gain.
3. The proposed gas dynamic coupling system at tail pipe exits locked successfully the two combustors in antiphase relationship with quick resonance and smooth operation.
4. Typical experimentally obtained noise spectra, for single combustor, show that very strong noise source is the firing frequency with the first few higher harmonics also being strong contributors.
5. The two coupled pulsed combustors at tail pipe exits results in the fundamental noise frequency being twice the firing frequency of the individual combustor.
6. Acoustic measurements indicate significant reduction of about 20 db in noise level due to coupling the two combustors. Coupling also entails improvement in muffling capabilities at the higher fundamental frequency and first higher harmonics. Improvement is also expected for the fully developed version of the pressure gain combustor.
7. Beneficial effect of precompression on thrust produced of the coupled combustors is realised experimentally.
8. The specific performance of the coupled unit is deteriorated when compared to the single combustor. Overall implication of results indicates that improvement of the present coupling system with inclusion of the return backflow from each combustor inlet to surround the combustor annularly and the whole unit is to be shrouded, is necessary if the potential advantages of mutual precompression are to be realized.

## REFERENCES

1. A. A. Putnam, et al, "Pulse Combustion", Progress in Energy and Combustion Science, vol. 12, No.1, 1986.
2. A. A. Putnam, "General Survey of Pulse Combustors" Proc., 1st International Symposium on Pulsating Combustion, Univ. of Sheffield, 1971.
3. P. Servanty, "Design and Testing of Harmonic Burners for Low Power Gas Turbines", Proc. of the 1st International Symposium on Pulsating combustion, Univ. of Sheffield, 1971.
4. J. Swithenbank, D. J. Brown, R. J. Saunders, "The Application of Pulsating Combustion to Power Generation Using Gas Turbines", Proc. of the 1st International Symposium on Pulsating Combustion, Univ. of Sheffield, 1971. ,

5. J.C. Kentfield, M. Rehman And E.S. Marzouk, "A Simple Pressure Gain Combustor for Gas Turbines", ASME Journal of Engineering for Power, vol. 99, 2, 1977.
6. J. C. Kentfield and P. Yernini, "Pulsating Combustion Applied to Small Gas Turbine". ASME paper, 85-GT-57, Gas Turbine Conference, Houston, Tex. 1985.
7. J. A. Kentfield and L.C. Fernandes, "Improvements to the Performance of a Prototype pulse Pressure Gain Combustor", ASME Journal of Engineering for Gas Turbines and Power, vol. 112, 1990.
8. "Pulsating Combustion", The collected Works of F.H. Reynst, Thring M.W. ed., Pergamon Press. Ltd, border, 1961.
9. J.F. Bertin, et al, "The SNECMA Escopette Pulse Jet". Interavia, 8(16), 1953.
10. B.G. Catchpole and A. Ruacres, "Constant Volume Gas Turbine Experiments with Gaseous Fuel in a Rotating Pocket Combustor", Mech. Engg. Rep. ARLIME 353, Aero-Research Lab., Dept. of Defence, Melbourne, Australia, 1974.
11. R.M. Lockwood, "Guidelines for Design of Pulse Combustion Devices, Particularly Valveless Pulse Combustors", Paper No. 14, Proc. vol. 1, Symposium on Pulse Combustion Applications, Atlanta, Ga, 1982.
12. L.M. Woodworth, "R&D. Activities in Pulse Combustion at BNL", Proc. Symposium on Pulse Combustion Technology for Heating application, Argonne National Laboratory Report ANUEES-TH-87, 1980.
13. R. M. Lockwood, "Pulse-Reactor Low Cost Lift-Propulsion Engines", AIAA Paper No. 64-172, AIAA General Aviation Aircraft and Operations Meeting, Kansas, 1964.
14. E.S. Marzouk, "Valveless Pulsed Combustors for Propulsion Application", Proc. of the 8th International Conference for Mechanical Power Engineering, Univ. of Alexandria, Egypt 1993.
15. V.S. Severyarin, "Application of Pulsating Combustion in Industrial Installations", Paper No. 7, Proc. vol. 1, Symposium on Pulse Combustion application", Atlanta, Ga, 1982.
16. R.M. Lockwood, "Drying Food and Wastes with pulsating Combustion", Proc. of the Symposium on Pulse Combustion Technology for Heating Applications, Argonne National Laboratory, Report, ANLIEES HM. 87, 1980.
17. J.N. Beiter, L. Docktor and R.C. Ellman, "Operating Experience with Lignite-Fuelled Pulse Jet Engines", ASME Paper No. 69-WAIFU-4.
18. N. Ohiwa, et al, "An Experimental Study of the Ignition and Combustion Mechanisms in Pulse Combustor", JSME International J., vol. 30, No. 268, 1987.

19. R.M. Lockwood. "Summary Report on Investigation on Miniature Valveless Pulse jets", Report No. ARD-307, Hiller Aircraft-Co, Palo Alto. Calif., 1962.
20. R.M. Lockwood. "Interim Summary Report on Investigation of the Process of Energy Transfer From Intermittent Jet to Secondary Fluid in an Ejector Type Thrust Augmenter", Report No. ARD-286, Hiller Aircraft Co. Palo Alto. Calif., 1961.
21. R.M. Lockwood and H.W. Sander, "Investigation of the process of Energy Transfer from an Intermittent Jet to a secondary Fluid in an Ejector Type Thrust Augmenter" Summary Report for the period 1962, to 1964 Hiller Aircraft Corp., Report No. APR 64-4.
22. S.G. Ahmed, "A Study in Valveless Pulsed Combustor and Gas Dynamic Coupling of Twin Combustor". M.Sc. Thesis, Dept. of Mech Eng., Alexandria University, 1995.

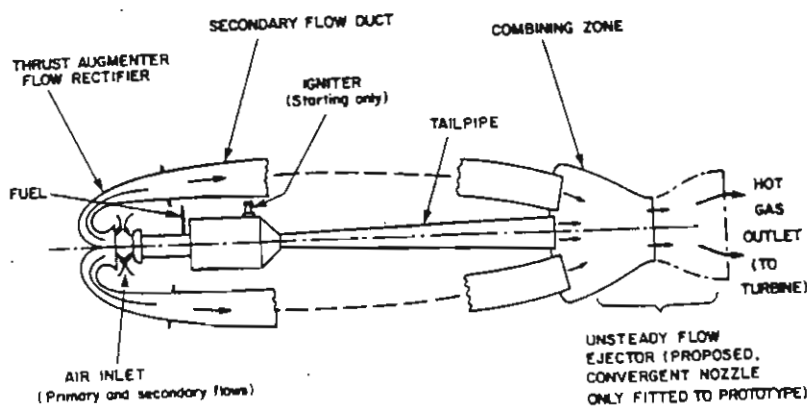

Figure (1) Arrangement of prototype pressure-gain combustor with thrust augmenter flow rectifier (Schematic) [5].

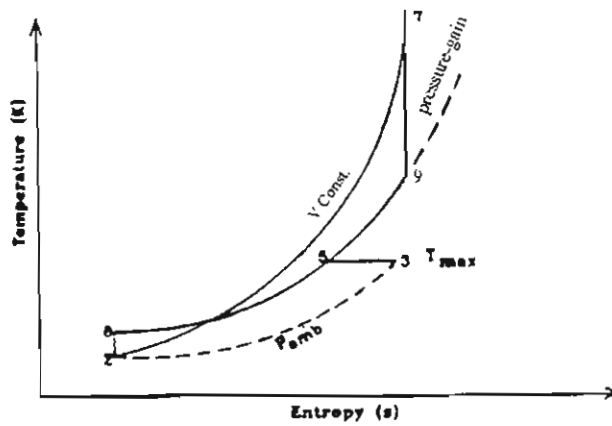
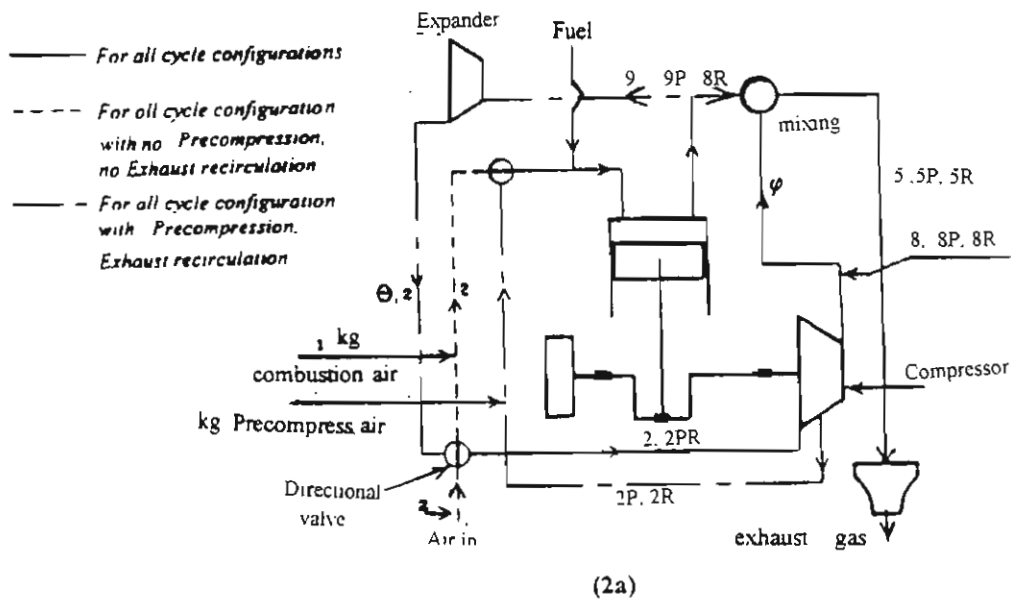

Figure (2) Thermodynamic model for evaluation of precompression effect on pressure gain.

(a) Hypothetical flow diagram.

(b) Pressure-gain (T-S) cycle representation for the case with no precompression and no recirculation

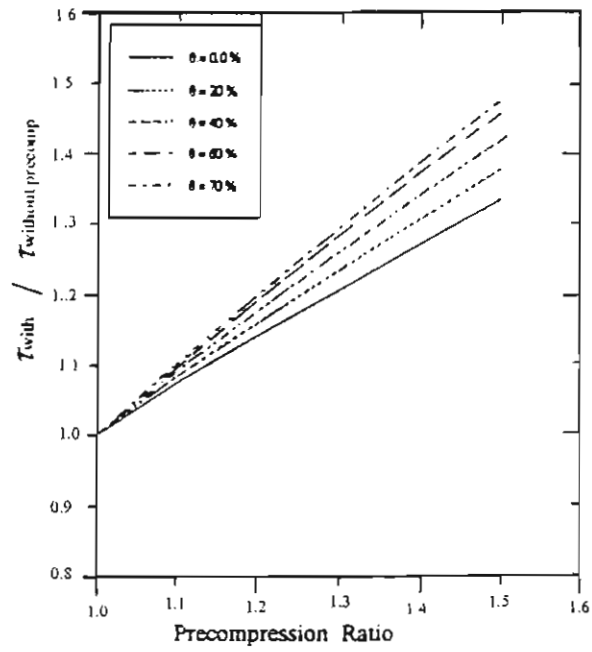

Figure (3) Predicted effect of precompression on thrust from constant volume combustion model combustor.

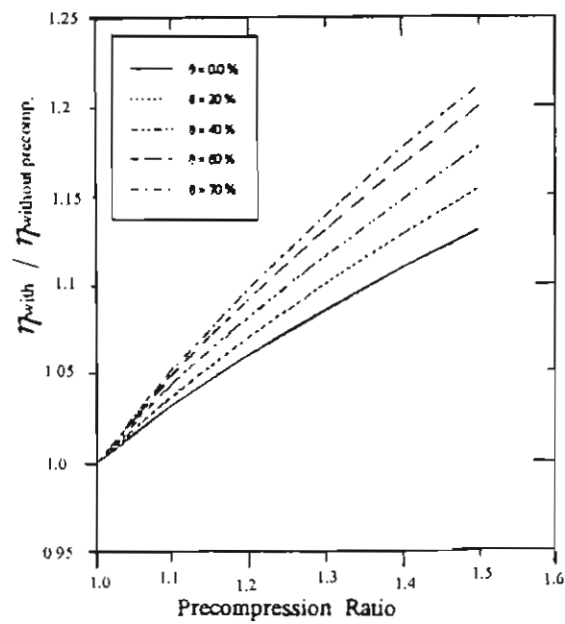

Figure (4) Predicted effect of precompression on thermal efficiency from constant volume combustion model combustor.

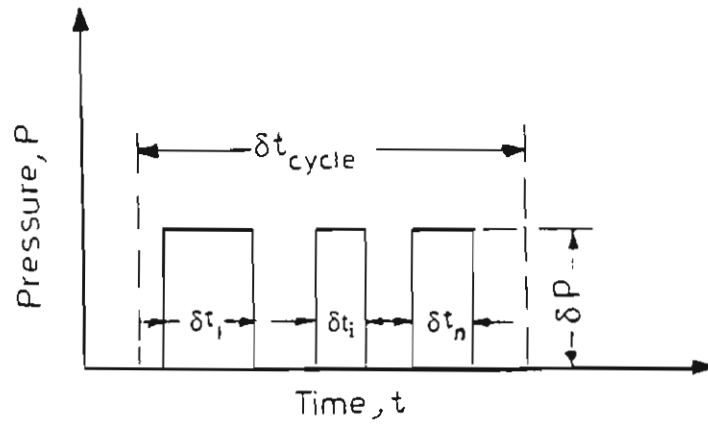

Figure (5) Diagram for assumed outflow pulses.

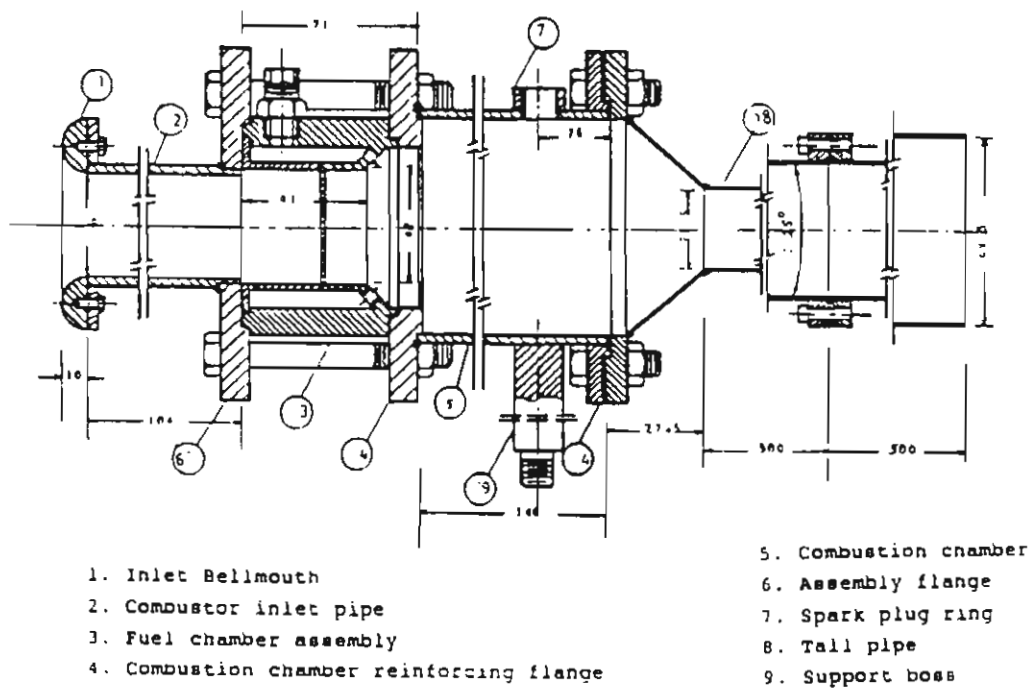

Figure (6) Construction details of the experimental valveless pulsed combustor.

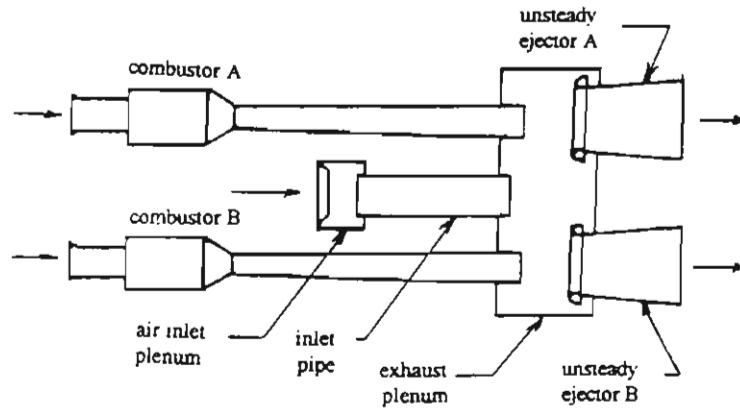

Figure (7) Arrangement for coupling at tail pipe exits (Diagrammatic).

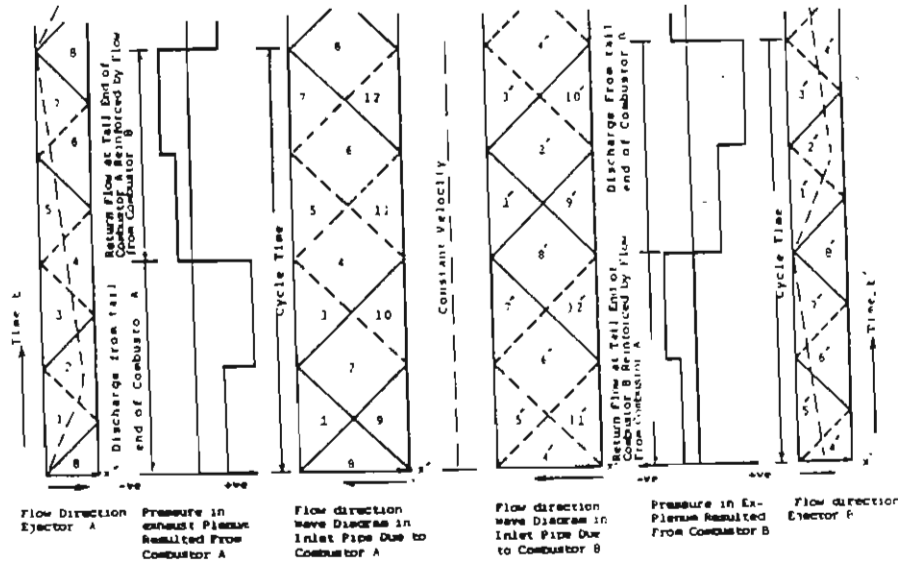

Figure (8) Simplified wave diagram for ejectors and air inlet pipe of coupling system.



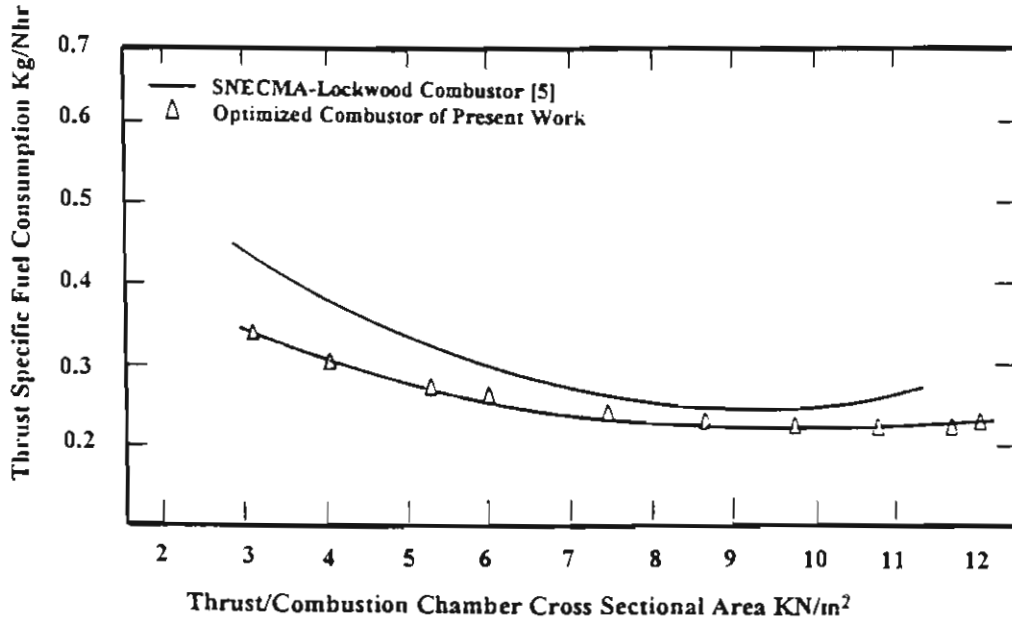

Figure (9) Comparison between performance of the optimized combustor of present work and SNECMA-Lockwood combustor [5]

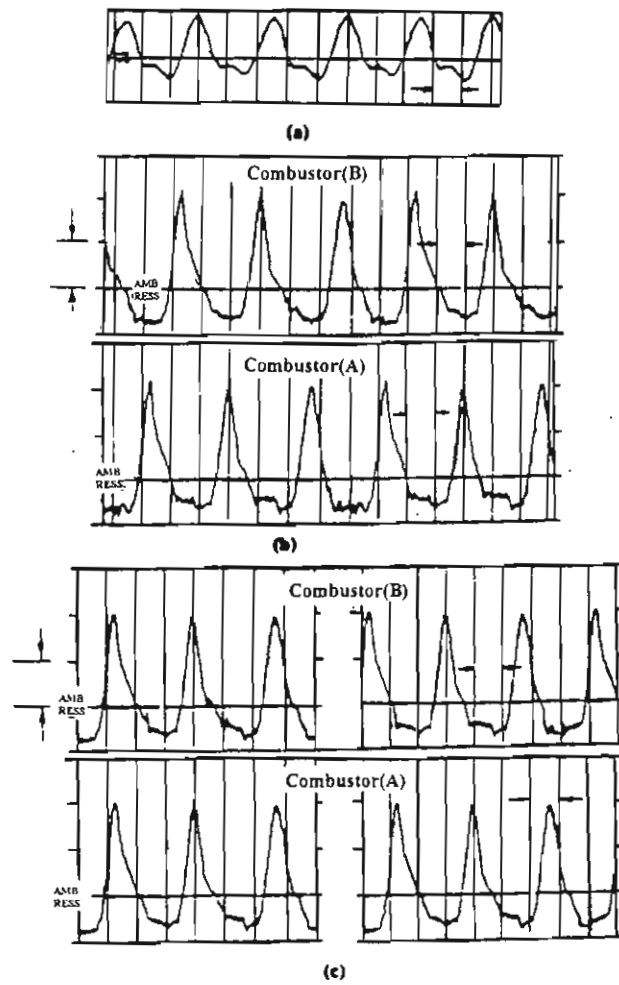

Figure (10) Combustion Space pressure -time traces for:  
 (a) Single combustor,  $m_f = 1130 \text{ Kg/hr.m}^2$   
 (b) Two coupled combustors.  $m_f = 2350 \text{ Kg/hr.m}^2$   
 (c) Dual combustors.  $m_f = 2350 \text{ Kg/hr.m}^2$   
 Vertical axis 70 Kpa/Div. sweep rate 2 m. sec/Div.

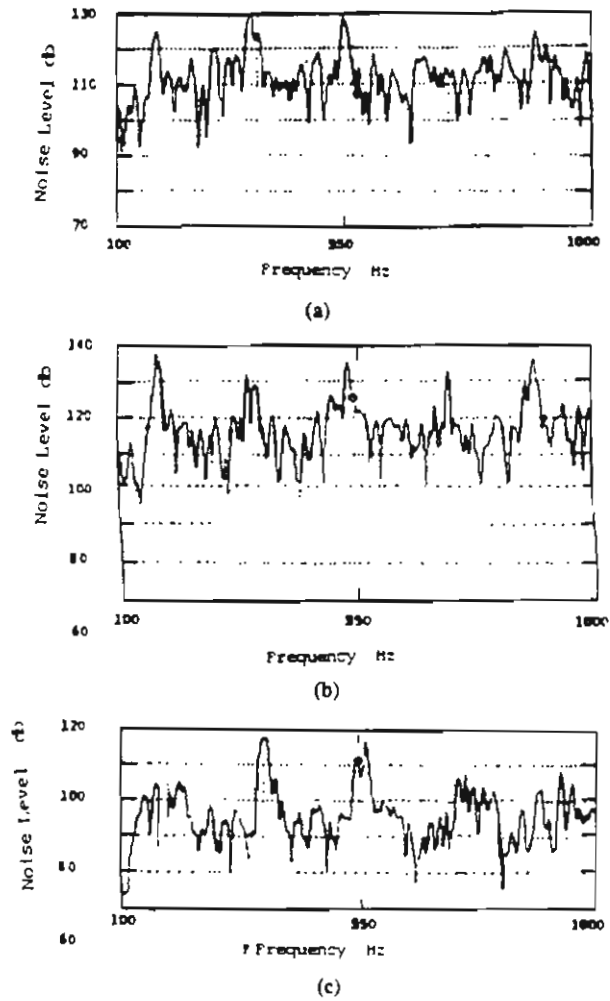

Figure (11) Measured sound Pressure level spectra for:  
 (a) Single combustor,  $m_f=1591.5 \text{ Kg/hr.m}^2$   
 (c) Dual combustors,  $m_f=1591.5 \text{ Kg/hr.m}^2$   
 (c) Two coupled combustors.  $m_f=2350 \text{ Kg/hr.m}^2$

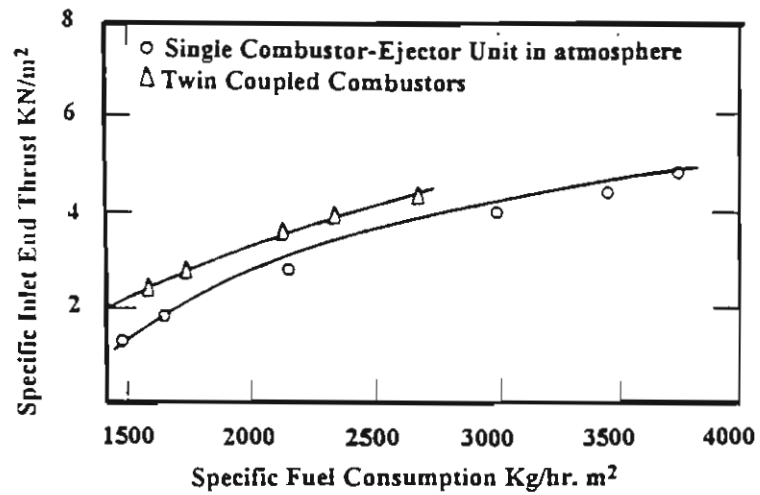

Figure (12a) Effect of coupling system on combustors performance in terms of inlet end thrust only.

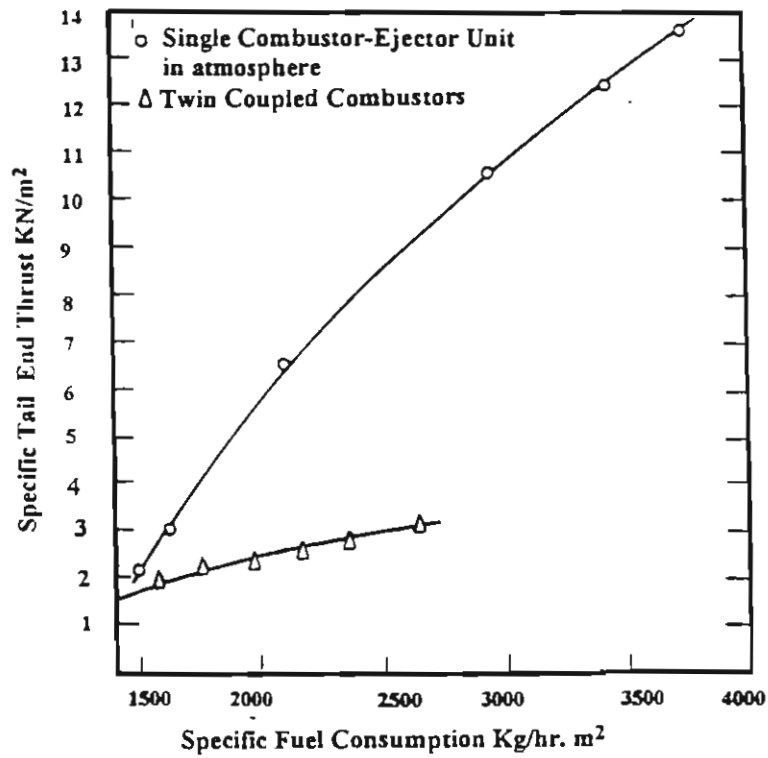

Figure (12b) Effect of coupling system on combustors performance in terms of tail thrust only.

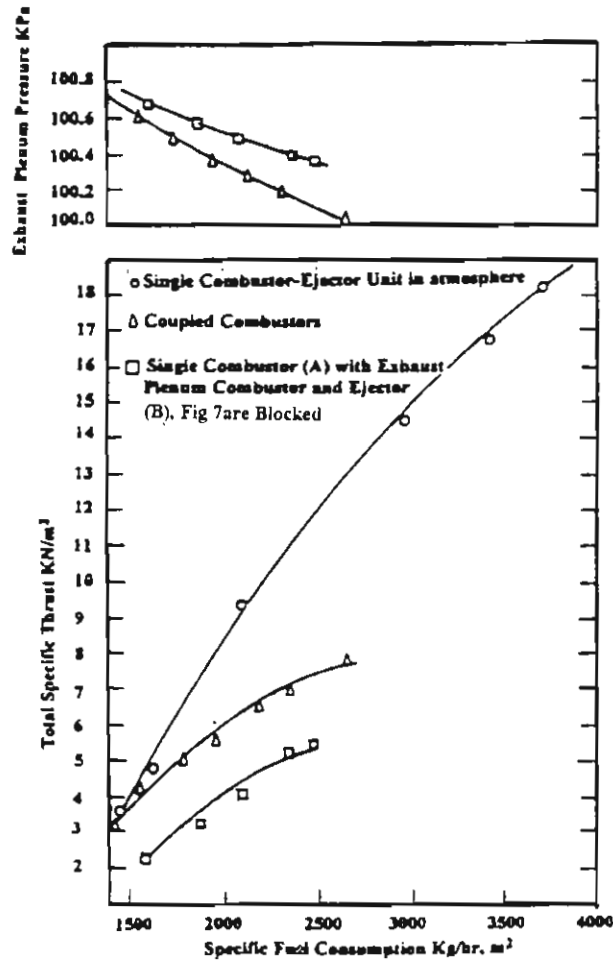

Figure (13) Effect of coupling system on combustors performance.