

CASE STUDY FOR REPLANNING THE LAYOUT USING GROUP TECHNOLOGY AND FLOW ANALYSIS TECHNIQUE

T.T. EL-Midany and A.M.M. EL-Bahloul

Associate Professor Dept. of Industrial Production Eng., Mansoura
Univ., Mansoura, Egypt

دراسة إعادة تخطيط ورشة إنتاج باستخدام أسلوب المجموعات التكنولوجية

الخلاصة - ان الحلول الدقيقة والمنطقية اقتصاديا ، تكلفة نقل ومداولة المواد ، المهارات المطلوبة ذات المستوى العالي ، انخفاض الانتفاع بسعة "بقدره" الصنعة ، انخفاض الاستفادة من القوى البشرية ، تجزئة المسؤولية للصنعة والتفتيش ، زيادة على ذلك أداة التخطيط الوظيفي لهي من العوامل الهامة والرئيسية في الحالة المعقدة للمواقع القائمة . ونتيجة لهذا ذكر سابقا كان الهدف من هذا العمل وهو دراسة حالة موجودة لإعادة تخطيط ورشة تطبيق أسلوب المجموعات التكنولوجية وذلك لجعل الورشة قادرة على انجاز وتحسين أو اصلاح جوهرى في النواحي المالية والأداء الاقتصادي وعمل تحسين ومانعة واضحة ومرقومة . وبصفة خاصة اعطاء فرصة لنقل المسؤولية واعطاء استقلال ذاتي أكبر على أرضية الورشة وزيادة قابلية تكيف توزيع العمال. هذا العمل تناول مناقشة دراسة حالة لأكثر من مائة منتج من أكثر المنتجات تكرارية ، متعددة العمليات على الماكينات ولها زمن انتاج كبير وذلك لايجاد عائلات الانتاج وتحديد العوامل اللازمة لتغيير التخطيط التقليدي للورشة الى التخطيط بواسطة المجموعات التكنولوجية/مجموعات الانتاج . تتابع العمليات وجداول ولوحات التحميل قد نفذت لكل منتج وحلت ونوقشت بدقة ثم حددت نقاط التقاطع لسير هذه المنتجات وذلك أيضا من المعلومات الناتجة من جداول التخطيط والرموز الخاصة بكل الأجزاء . استخدام عائلات الأجزاء ومجموعات ماكينات الانتاج نتج عنه ادراك التكاليف وتقليل المصاريف الغير مباشرة وتحسين المراقبة الاشرافية ، عماله وأعيانه في المجموعات ، تقليل زمن الانتاج وتكلفة المعدات وتقليل المخزون وزمن الأعداد والتجهيز ونظام تصميم أفضل وتقليل مداولة المواد وعدم الاحتياج الى مهارة عالية للعمال .

ABSTRACT

Finding logical and economical solution costly handling of material, high levels of skilled requirements, low utilization of manufacturing capacity, low utilization of man power, fragmentation of responsibility for manufacture and inspection, raised by the implementation of functional layout are of major importance of complex scheduling situation. Due to the above mentioned, was the aim of this case study to replan the shop layout by applying Group Technology (GT) technique, to enable the company to achieve substantial improvements in financial and economic performance and markedly to improve their general competitiveness. Particularly provided an opportunity to transfer more responsibility to and develop greater autonomy on the shopfloor and to increase the flexibility with which operators are deployed. The work discuss a case study for more than hundred components to find out the production families and determining the parameters needed to change from conventional layout to Group Layout (GL) or group manufacturing. The sequence of operations and the work load represented by each sheet, are analysed critically from information on the planning sheets and drawing for most of the components.

Families of parts and group of machine tools have been developed in order to achieve

cost and overhead reduction, effective supervision, more conscious workers in the group, reduction of the production time, tooling cost and reduction in stock and setting time, and well designed system, reduced work handling, and lower skill required are some of the system benefits.

INTRODUCTION

This case study has been carried out for more than one hundred components, manufactured for the Machine Tools Workshop in one of the Egyptian Companies. They were chosen to study the possibility of changing the existing layout (conventional functional layout) to group manufacturing "Group Technology" (GT), to overcome the manufacturing problems. The selected workshop produce all the spare parts, which they are required for the different departments of the company. The selected components have been chosen at random, but of highly occurrence in the workshop due to their urgent and annually demand, Fig. 1 illustrates a random group.

The philosophy behind the Group Technology concept may be regarded as an attempt at establishing a technological and organisational correspondence between the component part spectrum of a company and its shop floor facilities. This correspondence takes the form of a relationship between a collection of component part families and a collection of batch production cells.

Stressing the technological aspect, the "component family-production cell" correspondence will be seen to result in economical benefits such as faster work throughput and smaller work buffers. On the otherhand stressing the organisational aspect, this correspondence may result in personal benefits such as greater job variety and better job control.

Basically, GT can be defined as a method of organizing parts, processes and machines to take advantage of what they have in common to avoid redundancy. Thus, there is a possibility of increasing productivity through implementation of GT with coding and classification system, El-Midany [1]. In order to implement GT successfully and with a view to improving the overall economic situation of a production company, it is necessary to consider all aspects of complete manufacturing system [2].

STANDARDISATION AND GROUP TECHNOLOGY

The original increase in work productivity, particularly through the strengthening of work discipline, an improvement in the skill of workers and the raising of production quotas, is replaced by an increase in the technical and organisational standard of production, in which technology occupies a prominent position because:

- 1- It ensures the application of progressive methods.
- 2- It causes a reduction in auxiliary and idle time.
- 3- It produces a more favourable ratio of machine to manual work.

The main shortcoming of the technological preparation of production is the predominantly individual approach to the solution of every technological problem, for instance, in the heavy engineering industry, with mostly jobbing and small scale batch production, more than 75% of technologists are dealing with production data and preparing tool designs for future orders. In doing so they are treating the technology of production of each component separately, without considering any other similar components. They always work from the beginning, independently for every order, applying their own practical experience gained from production. The result is an unjustifiable non-uniformity of procedures for parts which are identical or similar in shape, a diversity in the specification of suitable machine tools and tooling and thus differences also in the standard production times. Apart from that, in those production branches in which there is a low standard of product design, and an inadequate standardisation of components, suitable conditions are not created for the specialisation of workshops, which would result in a substantial increase in productivity.

By the elimination of these fundamentals and other minor shortcomings, the technological preparation of production must reach a new qualitatively, as well as quantitatively higher level. The main measure to be taken is a fundamental change in the methods of work

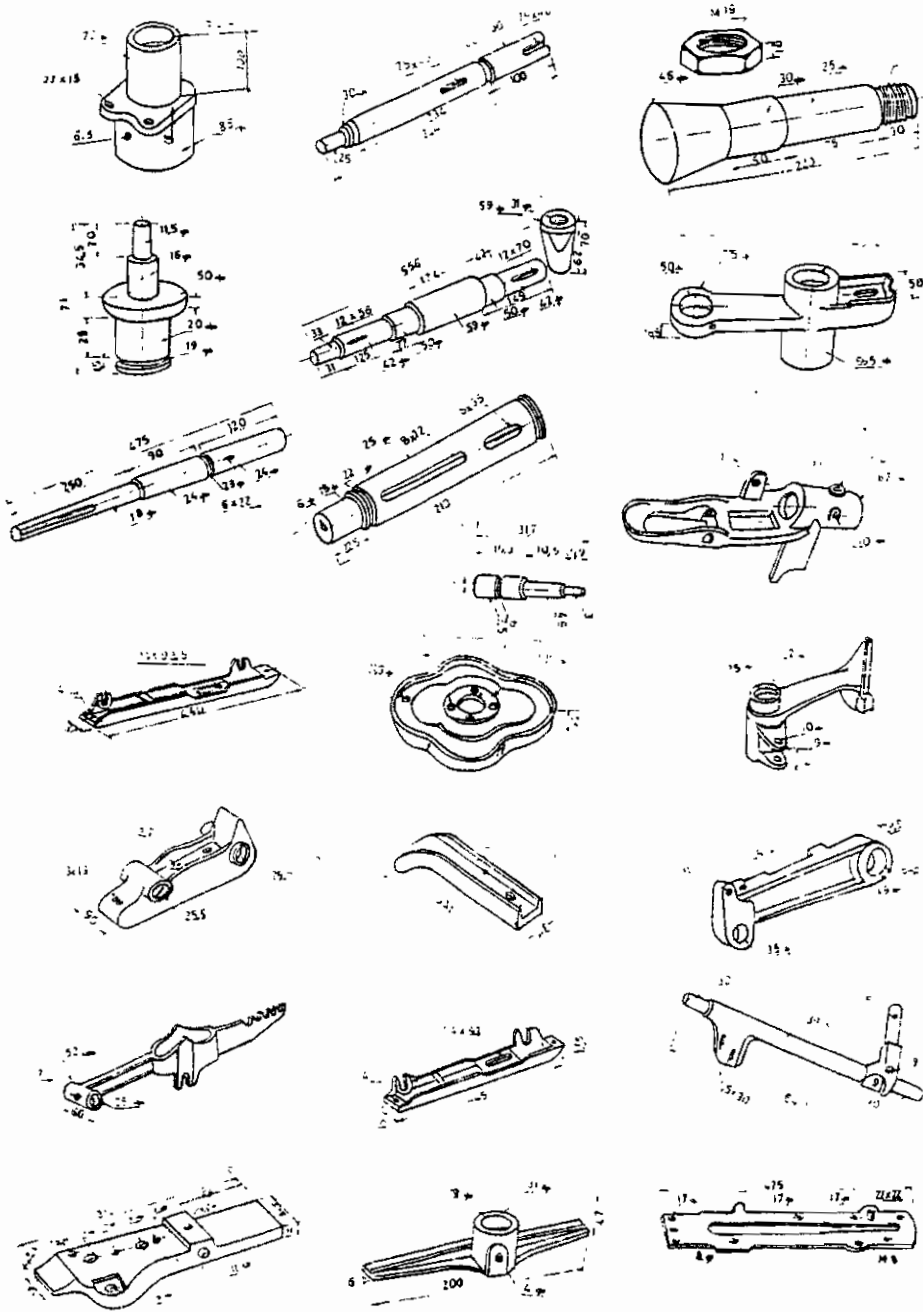

Figure 1 Random Group of Parts

of the technological sections. This will make possible a systematic and efficient activity on the basis of scientific research, and the research for new forms of work leading to the maximum effectiveness of production.

The new approach to improvement of the effectiveness of work in the field of technology, is referred to the standardisation of technology. It has the following general principles:

- 1- It should provide a better system for planning technological procedures, based on definite laws and methods.
- 2- It should afford the possibility of applying the accepted principles in almost all production processes and kinds of works, in machine shops, forging shops, foundries, stamping shops, tool shops, assembly shops etc.
- 3- It should achieve the production of similarly shaped parts, according to the optimum technological procedure for the given condition.
- 4- It should help to eliminate the shortcomings-particularly in jobbing and small scale batch production-of a vast quantity of tools and fixtures and a low utilisation of the time available for machining.

Following the introduction of the above general principles in engineering production, the scope of a comprehensive standardisation of technology, can be summarised in the following requirements:

- 1- To make analyses of the structural composition and development of the components, and to correctly plan to improve their effectiveness.
- 2- To improve the technological treatment of the design of components, as well as of the final products.
- 3- To apply type and group technology, which means to standardise the technology of production for components of similar shape and processing method.
- 4- By the unification of processing technology, to achieve larger batch sizes and thus also a higher type of production for component processing.
- 5- To introduce the specialisation of workshops and workcentres with a closed cycle, introducing equipment of new design such as unit heads, universally adjustable tools, group tools and fixtures and auxiliary equipment for the mechanisation and automation of production processes.
- 6- To improve the quality and reduce the cost for the preparation of technological documents.
- 7- To introduce a progressive organisation and control of production, and thus reduce the proportion of ancillary and idle time.

FORMATION OF COMPONENT GROUPS

Group Technology is a method of manufacturing component parts by the classification of the parts into groups and applying to each group similar technological and machining operations. The grouping of components increases the batch size and permits the use of flow line production of groups of machines with adaptable tooling and set-ups. This results in reduced throughput times and better utilisation of labour and existing equipment.

The essential characteristics for the formation of component groups which are suitable for manufacture by the GT process are shown in Fig.2. The formation of the component groups is facilitated by the use of classification and coding system. Component groups which increase batch sizes are developed in three distinct methods. For interest reader formation of groups and families has been explained more widely in a previous papers [1,2], as well as the total concept of the composite part.

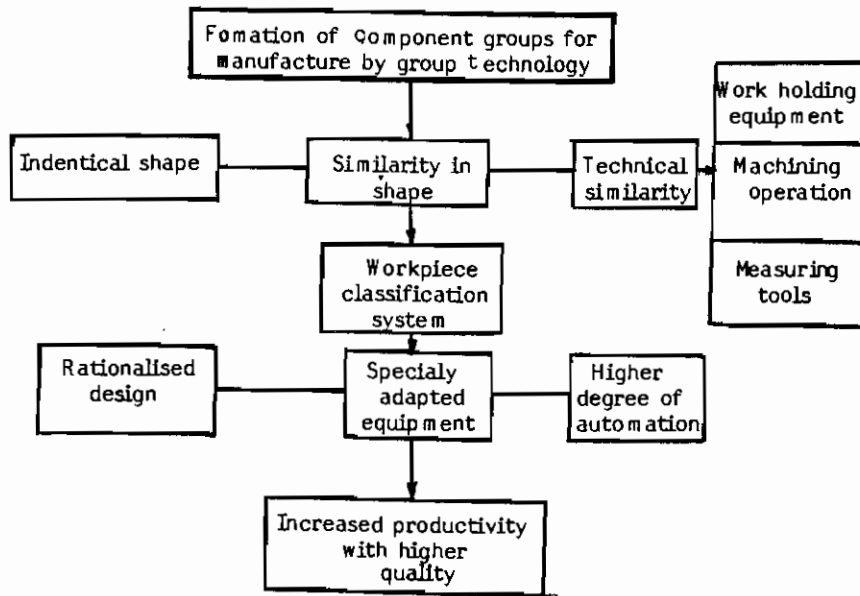

Fig.2. Manufacture by group technology

1- Identical Shape

Identical shape is achieved by standardisation, rationalisation and unification of components by designers. This makes it possible for the design department to use repeat parts and permits batch sizes to be increased.

2- Similarity in Shape

This method groups components by their similarity in shape and the necessity for identical or similar sequences of manufacturing operations. The standardisation and unification of the manufacturing and machining operations makes production with conventional machine layouts or with machine flow lines more efficient by reducing operation and setting times.

3- Technical Similarity

The third method is the grouping of components which require an identical sequence of operations. This promotes the development and use of machines with a high degree of automation. The first and second methods are complimentary and often occur simultaneously. It is by this grouping of components that rationalisation of machining processes, sequence of operations, operation and setting times, jigs and fixtures, tools and other ancillary items is made possible. This reduces the work content at all stages of manufacture and results in an overall increase in production efficiency.

CLASSIFICATION AND CODING FOR GT

The classification and coding systems suitable for use in GT have many common interfaces with systems for design retrieval and the basic rules of classification still apply. The system as a whole may be based on the geometric shape and/or the function of the component and/or the production requirements which are based on the tooling and machining requirements,[3]. However, classification by function should not be used unless the term is descriptive and has an exact meaning, e.g. shaft, piston, gear etc. Definite names and generic terms in current engineering terminology are not exclusive and components with

different functions can be given the same name even when used in the same equipment.

It is therefore preferable that the classification be based on the permanent characteristics of the components. The selection of characteristics and their systematic arrangement must be related to the overall requirements which the classification has to satisfy but should include:

- a. Geometric definition of external and internal shape,
- b. Other features such as holes, slots and splines, etc,
- c. Material and where practical the initial form, e.g. casting, forging, forming parts,
- d. Size.

These characteristics can be supplemented when required by other features such as levels of accuracy in machining, weight of component, etc. By the use of a classification system containing this type of information, components are sorted into groups. Each component within a group may then be studied and assessed for production by the group method of machining. The size of some component groups may be such that manufacture in their own right is not economic, but by merging one group with one or more other groups economic and efficient manufacture can be achieved.

PRODUCTION FLOW ANALYSIS PROCEDURE

Production Flow Analysis (PFA) is a technique used to simplify material flow systems and to find the families and groups for group layout. The technique is applied in four successive stages; factory flow analysis, group analysis, line analysis and tooling analysis. The main information needed to use it is an accurate route sheet for every component produced. Burbidge [4,5].

- a. The aim of factory flow analysis is to find the division into departments and the collection of machines and components to these departments, which will give the simplest possible material flow system.
- b. The aim of group analysis is to divide the components allocated to each department into families, and to divide the machine allocated to each department into groups, in such a way, that each family is completely processed by one group only [2]. The primary aim of group analysis is to achieve the simplest possible material flow system inside each department; to help in achieving this aim the following are adopted:
 - 1- As far as possible each part should be processed in one group only.
 - 2- As far as possible each machine type should exist in one group only.
 - 3- Incomplete processes should be in different groups.

It is obviously clear that, these aims are not always compatible, but they provide a useful guide. It is necessary to know which machine are visited by each component. In case to eliminate exceptions, the next steps can be used:

- 1- Re-process of operations to other machines already existing in the group.
 - 2- Change of method
 - 3- Change of component design
 - 4- Purchase component instead of making it.
- c. The aim of line analysis is to find the sequence of layout for the machines, which will give the nearest approximation to line flow.
 - d. The aim of tooling analysis is to find the division of the "families" produced in each group, into "tooling families" using the same tools.

ROUTE SHEETS

As mentioned previously, the main information needed for the analysis is found

on an accurate route sheets. Thus, let us go with more detail to illustrate the need for the route sheets.

Before the route sheets are used they should be checked for completeness and accuracy. The main points to be checked are that:

- a. There should be a separate route sheet for every made component, and for every assembly requiring further processing after assembly.
- b. Each route sheet should show all the operations used to make the item.
- c. The machine types used for all operations must be shown, Fig.3 illustrates machine codes
- d. The sequence should be an accurate record of the methods actually in use, or alternatively of methods which have been used and can still be used efficiently without buying additional tooling.
- e. Ideally the operation time per piece should be shown for each operation.

It will be seen that the level of consistency required in the sequence is not high. It is sufficiently accurate if all the machine types which are necessary to make each part are shown on the route sheets, and at least the majority of these are the best available or most commonly used for the purpose. However, the larger the number of inconsistencies which can be eliminated before analysis, the smaller will be the number of exceptions requiring special study correction.

GROUP ANALYSIS

The second stage of production flow analysis is called Group Analysis. The task is to divide the components allocated to each major family into families and to divide the plant allocated to each major group into groups [5], in such a way that each family is completely processed in one "group" only.

The primary aim of group analysis is to find the most efficient division of the major groups into "groups" of a required size. To help in achieving this aim, the following secondary aims are adopted. As far as possible:

- 1- Each part should be processed in one group only.
- 2- Each machine type should exist in one group only

These aims are incompatible and are not fully attainable in practice. Nevertheless they provide a useful guide to decision making. The most economical solution will generally be that which most nearly follows both of these aims. As reported by Burbidge [5], group analysis takes place in eight main steps as follows:

- 1- Renumber operations on route sheets,
- 2- Sort routes into packs,
- 3- Draw pack-machine chart, or component-machine chart,
- 4- Find families and groups,
- 5- Check loads and allocate plant,
- 6- Investigate and eliminate exceptions,
- 7- Specify group and families,
- 8- Draw final flow system network.

STEPS WITHIN THE CASE STUDY

The method used for sorting the hundred part into families of parts and the machines to groups, is best illustrated in the following Figures 4 and 5. Fig.4 illustrates the original record, which is the principles of Production Flow Analysis the initial part/machine chart for the machine shop. Fig.5 shows how the families and groups were found by changing the

sequence in which parts and machines were listed on the chart. The two charts are identical except that:

- 1- The sequences of listing for both parts and machines are different.
- 2- Some machine types have been installed in more than one group.

This study of the hundred components has been analysed to find out the production families and determining the parameters needed to change from conventional batch production methods to group manufacture.

The information provided on the route sheets and drawings provided from the company. The previous discussed procedure for PFA has been considered and followed during this study.

Fig.6 illustrates the original functional layout-which exists in reality, and the flow of the hundred selected components due to their sequence of operations. From the figure one can show a real comparison between the functional layout and the group layout (six groups) illustrated in Fig. 7. These groups have been designed after sorting the parts and machines into six families and groups using GT concept. The criteria upon which we divide to six groups layout is due to the machining time for each part and the full utilization of the machine tool, which aids effort to increase the overall productivity.

DISCUSSION

Group Technology is a way of identifying and bringing together related parts so that design and manufacturing can take advantage of their similarities. Parts with design and manufacturing similarities are grouped into families; a hundred different parts (our case) are grouped into six families (as illustrated) of similar parts. The result is a significant reduction in the number of unique work problems confronting design and manufacturing.

Classification is the method used to identify design and manufacturing characteristics of parts and to relate these characteristics or attributes to a coding system that facilitates their retrieval.

Design engineers are faced with the problem of designing many different parts. Without an effective design-retrieval system, there is no way to determine whether a new part is really new, has been made in the past, or is similar to a part made in the past. There is also no way of knowing what effect specific design decisions will have on ultimate part-manufacturing costs, because there is not much feedback from manufacturing to design which respect to the relative manufacturing costs of design decisions. Faced with this information void, the path of least resistance is to design from scratch, to "reinvent the wheel" in many cases. The result can be an overwhelming design proliferation as the same part is designed several times, each time with a slightly different tolerance or shape.

The same kinds of pressures can lead to manufacturing problems also. The trend to more product variations has increased the emphasis on shop flexibility and has led to a proliferation of manufacturing-process plans, with no means of drawing on experience or an information retrieval system.

It is very clear now, that, the outcome of all of this has included high machine tool investments per unit produced, high costs for manufacturing-process planning, high tooling costs, complex scheduling and machine loading, high setup time and cost, high scrap rates, and high quality-control costs.

Thus, in other words, inefficiency has increased and, as a result, costs have increased. Now, one can say that Group Technology, classification and coding, and computer Aided process planning-which create concise route sheets-are responses to these problems; thus more benefits could be realized from applying GT, more benefits with GT as reported by El-Midany [1].

CONCLUSION

The economic effects of GT are of major significance, but it is possible that in

the long run its sociological effects will be of even greater importance. The substitution of independent groups of people working together towards common aims, for groups of process specialists each making independently, should make it possible to delegate more decision making to foremen and workers and introduce a greater measure of worker participation. The simplification of the material flow system again should reduce the need for centralized bureaucratic direction and control, and for close co-ordination between departments and groups, thus greatly reducing stress and chances of conflict.

In reality GT application has introduced many advantages from a management stand point, as it impacts planning and support control for manufacturing and as it impacts manufacturing. GT, is a progressive approach to the work of the sections of technological preparation of production and of production process control. The degree of its effectiveness depends fully on the consistency and thoroughness of its application.

REFERENCES

- 1- El-Midany, T.T. "Group Technology Techniques as Applied in Replacing the Layout of Small Workshop", 2nd IASTED Intr. Symposium, on Applied Modelling and Simulation, Simulation III, June 29, Paris, France (1982).
- 2- El-Dardiry, M.A. and El-Midany, T.T. "Flow Analysis Technique for Jop Shop Planning", 2nd Intr. Conf. PEDAC 83, Alexandria Univ. pp.649-660, Dec. 27-29, Egypt (1983).
- 3- Machine Design, Part 1, Classification and Coding, pp 142-147, July 21 (1966).
- 4- Burbidge, J.L, "Production Flow Analysis" GT Proceedings of an Int. Saminar held at the Turin. Int. Centre, 89-123, Italy (1989).
- 5- Burbidge, J.L, "The Introduction of Group Technology", Butler and Janner Ltd, Forme and London, UK (1975).









SYMBOL	M/C
	CENTRE LATHE
	AUTOMATIC LAHE
	SHAPPER
	PLANER
	HORIZONTAL MILLING
	VERTICAL MILLING
	AUTOMATIC MILLING
	DRILLING M/C
	SLOTING M/C

Figure 3 Machine Codes

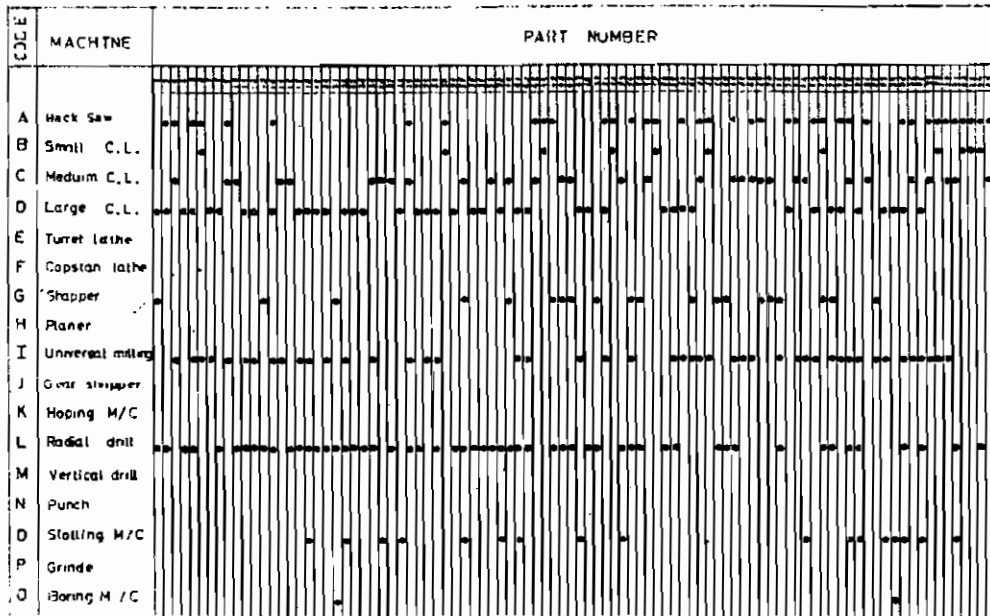

Figure 4 Parts/Machine Chart (Original/Record)

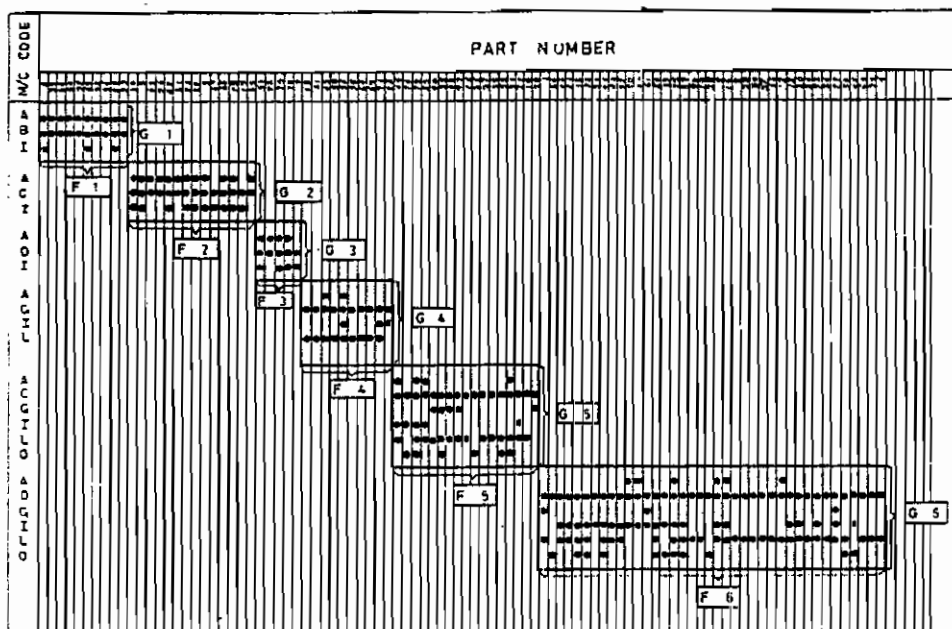

Figure 5 Family of Parts and Group of Machines Analysis

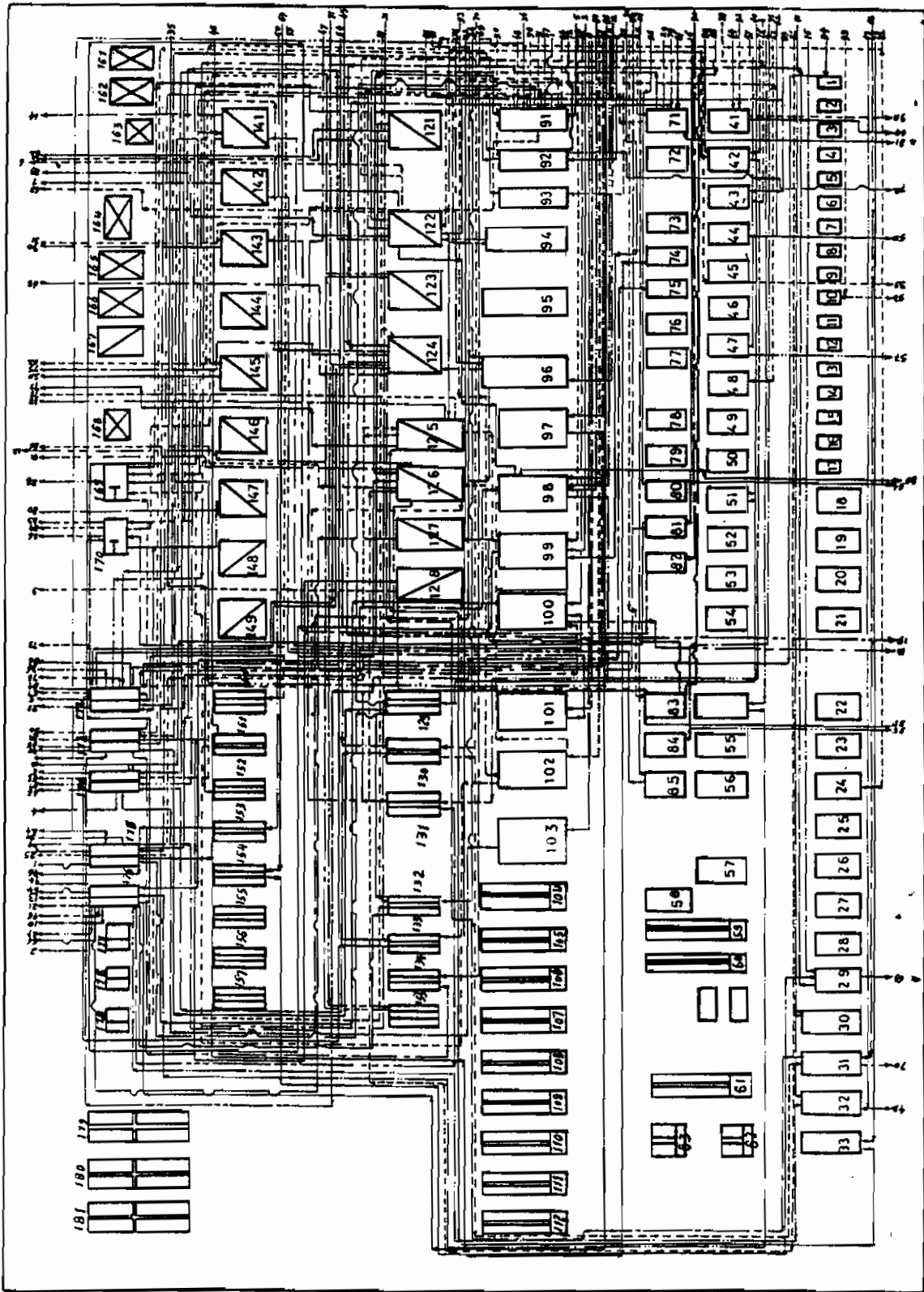

Figure 6 Original Functional Layout

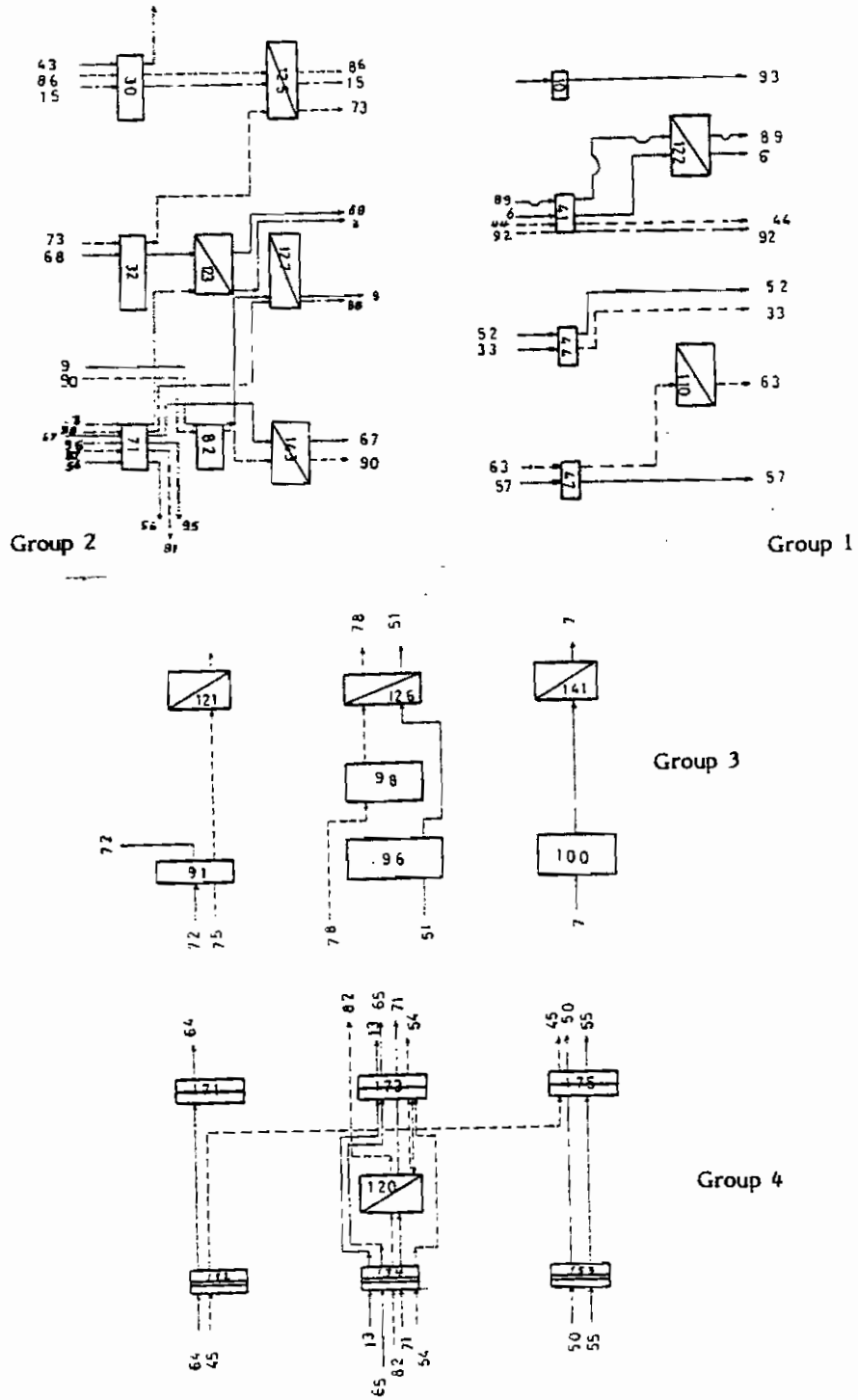

Figure 7 Group Layout

