

"THE MOST ECONOMIC COMBINATION OUT OF PHOTOVOLTAIC
(PVPS)/WIND (WES)/BATTERY STORAGE (BS) SYSTEMS AND
APPLICATION FOR EGYPTIAN SITES

تكوين العجومة الأكثر اقتصادية من منظومات الخلايا الكهروضوئية
(الفوتوفولتيه) / الرياح / بطارية تخزين ونطبق على مواقع

مصرية

H.H. El-Tamaly
Lecturer, IEEE M
Faculty of Engineering,
Elminia University
Elminia, EGYPT.

M.H. El-Maghraby
Professor, IEEE SM
Faculty of Engineering
El-Mansoura University
El-Mansoura, EGYPT

خلاصة - تقدم هذا البحث طريقة مقترحة لاجداد أفضل المصنوعات الاقتصادية والتي يمكن تركيبها من منظومة الطاقة الكهروضوئية (العوتوفولتيه) ومنظومة طاقة الرياح ووحدة من بطارية تخزين لسفدية الحمل السرمي المطلوب تحت تأثير فيود كمية واقتصادية . وقد تم استخدام بيانات فعلية ودمقة للاشعاع الشمس والسرعة الرياح تم تسجيلها لحظيا على مدى الأتوام السابقة - وذلك لاجداد التصميم الأمثل للمنظومات المذكورة . وتم اجراء تطبيق كامل للطريقة المقترحة برمجتها وتشغيلها على الحاسب الرقسي الشخصي واستنباط وتحليل شكل المنحنيات الخاصة بالأعمال اليومية المطلوب تنفيذها وكذلك الخاصة بخرج المنظومة العوتوفولتيه ومنظومة الرياح والمفروض انشاؤها في موقعى مرسى مطروح وشرق العوينات بجمهورية مصر العربية وتم الاستغناء عن بطاريات التخزين أو تقليل محتواها إلى أقل حجم ممكن وذلك بتطبيق ما اقترحناه وأطلقنا عليه هذا الإدارة الأعمال بمساعدة منظومات الطاقة الكهروضوئية وطاقة الرياح - كما تم ايجاد وتحليل التأثيرات الناتجة عن أخذ نمب مختلفة لخلل منظومات الطاقة المتحددة هذا على حجمها . ولقد تم ايجاد سعر الكيلوات ساعة المنتج من المنظومات السابقة ووجد أنه ١٢٦.٠ دولار أمريكي (٢٩٩.٠ جنيه مصرى) و ١١٦.٠ دولار أمريكي (٢٥٥.٠ جنيه مصرى) لسوقى مرسى مطروح وشرق العوينات على الترتيب - كما تم تحدد الوحدة المثلى ونسبة نخلل كل منظومة لكل موقع من الموقعين السابقين .

ABSTRACT- This paper presents an approach by the aid of which combinations of photovoltaic (PVPS), wind (WES) and battery storage (BS) systems are investigated in supplying a daily load demand subject to a set of technical and economical constraints. On solving the design problem, accurate and short-term solar radiation and wind speed data are used. Seasonal variations in demand and climate as well as distinctive penetration levels of the renewable energy system effect appreciably the design parameters.

The proposed approach has been extensively applied and programed to be run on a personal computer. The demand and generation output profiles are deduced and analysed for distinctive penetration levels of both PVPS and WES hypothetically installed at Mersa-Matruh and East-Oweinat in EGYPT. The BS is eliminated or reduced having a minimum capacity by applying what we call and propose, here, as PVPS and WES-aided load management.

These systems result in competitive energy cost figure of \$ 0.0136 (0.0299 L.E) and \$ 0.0116 (0.0255 L.E) /kWh for Mersa-Matruh and East-Oweinat as egyptian sites respectively. The mosteconomic energy combination is thus deduced with the respective optimum penetration levels of their systems.

INTRODUCTION

A rapidly growing global population with higher expectations will require increases in the consumption of fossil fuels in the years to come. However, t

global deposits of fossil fuels are already being depleted at an alarming rate. The extreme shortages in conventional energy supplies and the indiscriminate exploitation of natural resources have resulted in large scale deforestation and famine in many parts of the world. Lack of facilities and employment opportunities in the rural areas have led to mass migration and overcrowded mega-slums around cities, resulting in further detrimental effects on the social and economic progress, and the environment in developing countries [1].

Remote rural areas, like which located in EGYPT, typically do't have and are't expected to have electric grid supply in the near future.

It appears that harnessing locally available renewable resources to supply the energy needs of remote rural areas is an option that deserves the serious consideration of energy planners, especially in countries that do't have adequate fossil fuel resources.

This paper presents an approach by the aid of which combinations of PVPS , WES and BS systems are examined and operated for meeting a daily load demand throughout the year.

Three alternatives are practically possible and investigated. The first one is to feed that load by a combination of PVPS/WES/BS. The second alternative is to use a combination of PVPS/BS systems aiming at supplying the same daily total load demand while the third one is to integrate the WES with BS systems.

The most economic combination has been governed by several factors like the solar cells array, wind turbine generators and battery costs and their technical characteristics. Thus, a comparative study with complete analysis has been carried out to find the most economic combination for the egyptian sites under study. The introduced approach has the advantage of its ability to deal generally with any site and load requirements.

GLOSSARY OF NOTATIONS

S_n	= The n th site, n = 1,2,3, . . .
t	= Time, hours
L (t)	= Hourly Load Demand, MW
L E	= Daily Energy Demand, MWh
L_p	= Peak of Daily Load Demand, MW
t_p	= Peak Load Starting Instant, hour o'clock.
L F	= Load Factor, p.u.
SC	= Solar cells size, m ²
SCA	= Solar cells Array
S	= Solar cell size, m ²
S^0	= Initial value of solar cells size, m ²
p (t)	= Hourly output of PVPS, kW
PVPS	= Photovoltaic Power system
P E	= Daily output Energy of PVPS, kWh
TLy	= Penetration Level of PVPS output, p.u.
q	= Solar Cell Thermal Resistance, m ² . C° / kW
I TH	= Hourly Solar Radiation Received by horizontal surfaces, kW/m ² .
I Tt	= Hourly Solar Radiation Received by surfaces tilted by the Monthly Best Tilt Angle at the site under study, kW/m ² [2 ,3]
T A	= Ambient Temperature, °C
$T_c(t)$	= Hourly cell Temperature, °C
η_{cr}	= Theoretical Solar Cells Efficiency, P.U.
F	= Fractional Decrease of Cell Efficiency, P.U.
T_{sc}	= Theoretical Operating Temperature of the Solar Cell, °C.
$\eta_{sc}(t)$	= Hourly Efficiency of the Solar Cell, P.U.
F S	= Factor of safety includes an Allowance for the possible Inaccuracy of solar Radiation Data for the Maximum Possible Variation from the Average Weather Conditions and for the probable loss in the Array Output due to its obscuration by Dust, P.u.

VF	= Variability Factor Takes into Account the Influence of the variation in the solar Radiation from Year to Year, p.u.
PC	= Power conditioner
η_{PC}	= Power conditioner Efficiency, p.u.
WTG	= Wind Turbine Generator
WES	= Wind Energy System
N_w	= Number of WTG units
N_w^0	= Initial Number of WTG units
$W(t)$	= Hourly Output of WES, kW
WE	= Daily Output Energy of WES, kWh
V_t	= Hourly Wind speed, m/s
V_r	= Rated Wind speed, m/s
V_{ci}	= Cut-in Wind speed, m/s
V_{co}	= cut-out Wind speed, m/s
A	= Swept Area of the wind Turbine Rotor, m^2
CP	= The ratio of Power Absorbed by the Wind Turbine Rotor to the Power inherent in the Wind.
TL_w	= Penetration level of WTG Output, p.u.
ρ	= The density of air, kg/m^3
T	= Air Temperature, °K
P_r	= Air Pressure, mm of Hg
V_p	= Pressure of water vapor, mm of Hg
η_m	= Mechanical Transmission Efficiency, p.u.
η_g	= Electrical Generator Efficiency, p.u.
BS	= Battery storage Capacity, kWh
C_s	= Solar cells Price, \$ / W_p
CB	= BS Price, \$ / kWh
U	= Energy cost Figure, \$ / kWh

2 PROPOSED APPROACH

2.1 Main Intention.

The principal aim of this work is to determine the most economic energy combination out of three appropriate alternatives. The Photovoltaic (PVPS) and Wind energy systems (WES) integrated with a battery as a storage constitute them. Since the first two renewable systems are site-dependable, thereby, the proper combination will differ according to the sites under consideration. Economic grading of the studied combinations to be installed for each site is possible out of the attainable numerous results.

2.2 Factors Affecting Solution.

Since the final conclusions are governed by many technical and economical factors and constraints, an approach should be proposed to deal with them: in tackling the problem. Of these factors, the type of solar radiation and wind speed data (hourly, average monthly or yearly), possibility of applying storage during the deficit periods, the problem of how to meet the load at low insolation, cloudy and night periods with respect to PVPS in one side and the periods of meeting the demand during which the wind speed may be less or more than the cut-in and cut-out speeds respectively in the other, role of battery storage toward these obstacles, prices of system components particularly those of the solar cells array and battery at the present and future times and eventually the hopeful accuracy in solving the problem.

2.3 Energy Combinations.

Fig. 1 displays the subsystems constituting the investigated combinations with their specifications presented in the Appendix.

2.4 The Proposal.

2.4.1 Assumptions and Flow Chart.

In a previously published paper [4], the authors had recommended the use of a full

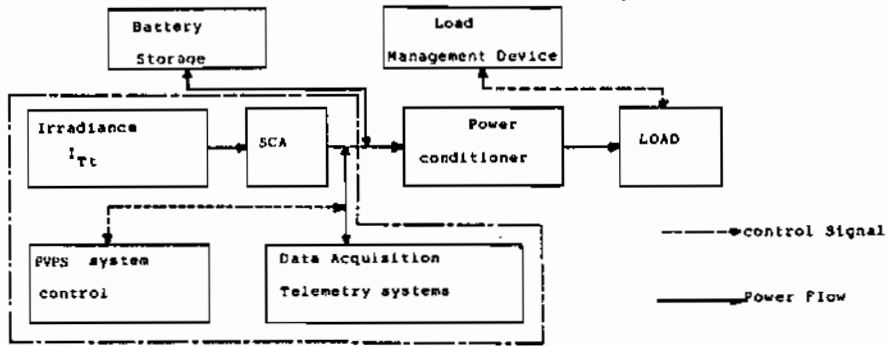

Fig.1 - a Scheme Diagram of PVPS/BS Energy combination .

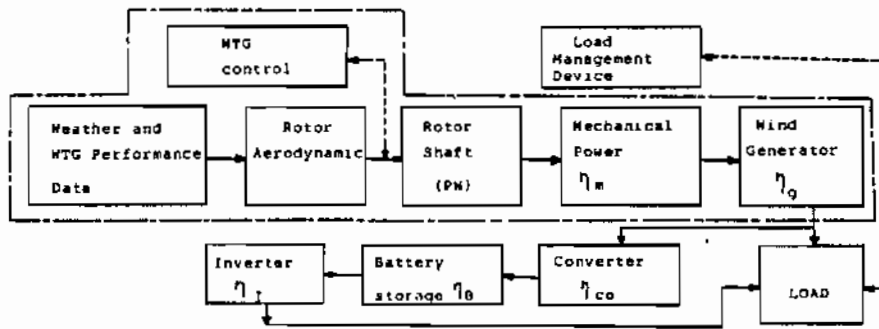

Fig.1 - b Scheme Diagram of WES/BS Energy combination.

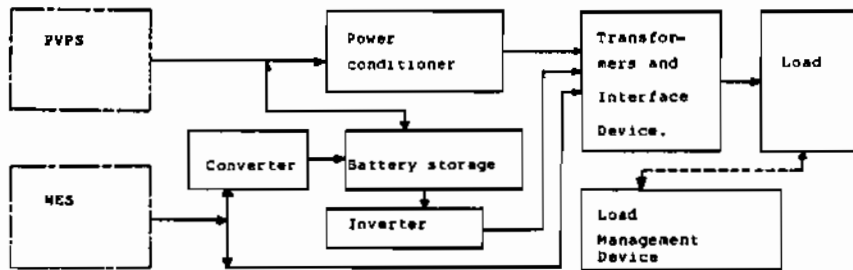

Fig.1 -C Scheme Diagram of PVPS / WES / BS Energy Combination.

year hour-by-hour wind data so that the storage system charge and discharge operations can be simulated. Moreover, the use of actual wind speed data stems from the fact that neither statistical model (either Weibull or Rayleigh) is perfect and it is difficult to make broad generalization about the ability of both density functions to fit actual data [5]. Thus, actual hour-by-hour insolation and wind speed data of the year months are taken, here, as inputs for the researched sites. The flow of these data throughout the application of the proposal is shown in Fig. 2. In addition, the followings are the significant assumptions that taken into account on applying the suggested approach :

- 1- on solving the design problem of first energy combination: PVPS and BS, a number of solar cells modules is determined and aimed to be installed to charge the battery for meeting the load during the night and cloudy periods. Other modules power the demand throughout the daytime hours of utilizable insolation.
- 2- With the regard of the second combination: WES and BS, the battery will be integrated with the WES when the wind speed being less or greater than the cut-in and cut-out speeds respectively. The necessary number of WTG units is derived according to the seasonal daily energy demand. The battery has been charged during the periods of high wind energy output in excess of the corresponding load levels. It is to be discharged in the intervals of low WES output.
- 3- With the concept of operating the PVPS, WES, and BS as the third alternative, their design parameters are deduced according to their simultaneous operation throughout part or all of the daytime period. The BS would be employed, if necessary, to meet the demand during the night, cloudy, and low wind speed periods. Different penetration levels of the formers are investigated economically to decide the best levels.
- 4- The. SCA and WTG output is totally utilized throughout the day hours.

2.4.2 Development of PVPS, WES, And BS Sizes

(a) Derivation of SCA Size and Capacity of Its Accompanied Battery Storage at Different Penetration Levels (TL_V)

i) Having the input data of SC, PC, BS, LE, L (t), I_{TH} and I_{Tt} , ambient temperature for researched sites and TL_V .

ii) The final SCA size for certain rated power fulfills the energy balance condition. Starting with an area of $S = S^0$, the corresponding hourly output can be estimated using the following equation:

$$P(t) = 10^{-3} S I_{Tt} \eta_c(t) \eta_{pc} / FS \quad \text{MW} \quad \dots (1)$$

Where $\eta_c(t) = \eta_{cr} [1 - F(T_c - T_{cr})]$

$$T_c = T_A + q I_{Tt} \quad ^\circ\text{C}$$

The monthly average daily photovoltaic energy output (PE) is, then, found by:

$$PE = \sum_{t=t_1}^{t_2} P(t) \quad \dots (2)$$

It is compared with the seasonal daily energy demand (LE) penetrated with TL_V resulting in the following probabilities :

1. $PE > LE * TL_V$, then , the prechosen size, S^0 , should be decreased with an area (Δ) and repeating the foregoing process.
2. $PE < LE * TL_V$, S^0 will be modified by a (Δ) to have higher size and eqns(1) & (2) are applied again.
3. If $PE = LE * TL_V$, then the chosen SCA area satisfies the energy balance condition and is taken .

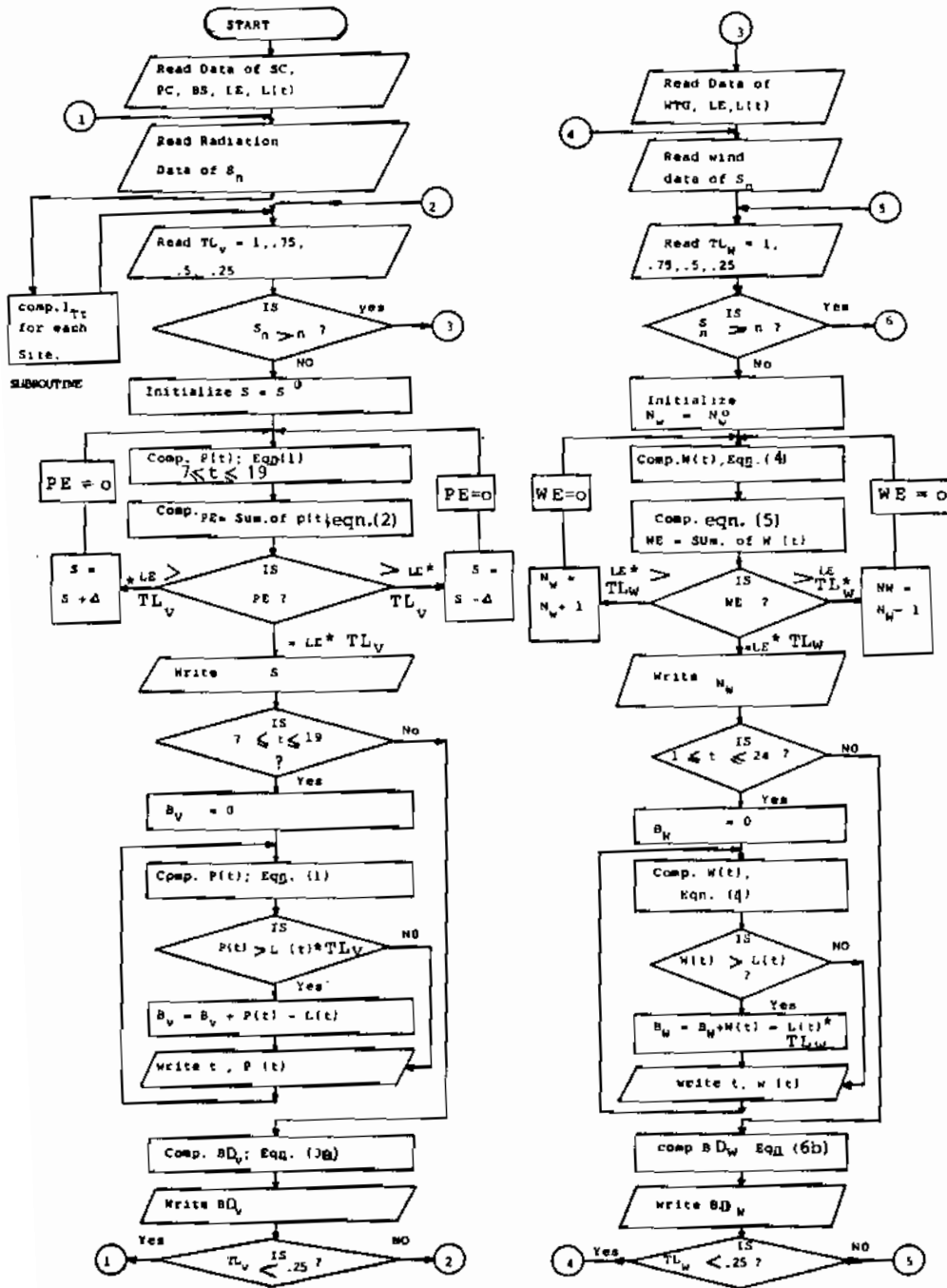

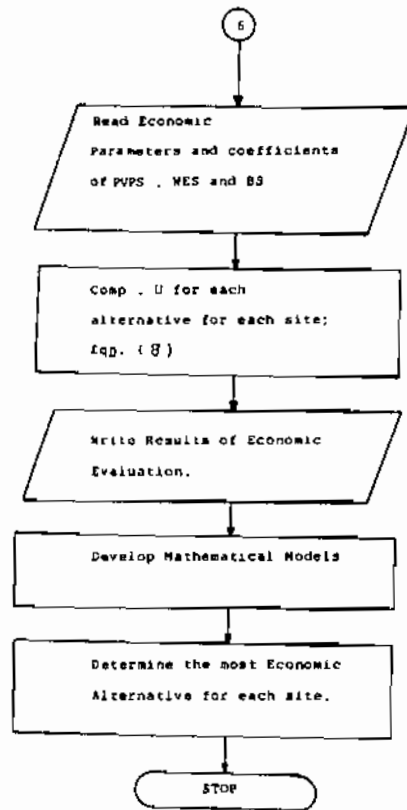

Fig.2 Flowchart of The Proposed Approach.

iii) The battery integrated, here, with the PVPS has a capacity BS_V comprising of two parts. The first, BD_V , is to be charged by the surplus energy during the high insolation period and being discharged to power the load demand throughout the low insolation one. The other part, BN_V , is needed to meet the night and critical load. The capacity BD_V is found as :

$$BD_V = B_V / \eta_B \quad \dots (3-a)$$

where

B_V is the surplus energy available during high insolation periods estimated by :

$$B_V = \sum_{t=t_1}^{t_2} (P(t) - L(t) * TL_V)$$

This summation is accomplished only for the condition of $P(t) > L(t) * TL_V$, and $P(t)$ is derived by applying eqn (1) for the final and correct SCA size

$$\text{Also, } BN_V = \text{Night and critical loads} * TL_V / \eta_B \quad \dots (3-c)$$

On the other hand, the total capacity BS_V can considerably be reduced by applying what propose, here, as the PV - aided load management strategy. The load demand profile is, thus, modified to be the same as the PVPS output. That is, the majority of the night loads, except the lighting and critical ones, are shifted and powered throughout the daytime.

(b) Deduction of the Number of WTG Units and capacity of Its Accompanied Battery with Various Penetration Levels (TL_W)

i) Having the data of the candidate WTG, wind speed along the year (hourly) and air pressure of the investigated sites and penetration level of WTG output.

ii) On the basis of energy balance condition, the number of WTG units is derived. An initial number of WTG, N_W^o , is, thus assumed for which the hourly electrical output, $W(t)$, is estimated as follows [6] :

$$W(t) = 10^6 * 0.5 \rho A N_W V_t^3 C_P \eta_m \eta_g \text{ Mw} \quad \dots (4)$$

for $V_{ci} < V_t < V_{co}$

where, $\rho = 1.2929 (P_r - VP) 273/760 T \text{ kg/cm}^3$

So, the monthly average daily WTG energy output is calculated from :

$$WE = \sum_{t=t_1}^{t_2} W(t) \quad \dots (5)$$

Satisfying the condition of $V_{ci} < V_t < V_{co}$

The WTG output given by this eqn will be compared with the seasonal daily demand penetrated by TL_W as follows :

1. If $WE > (LE * TL_W)$, then the initial number N_W^o should be decreased with a decremental value, say, one unit as explained by the flowchart.
2. If $WE < (LE * TL_W)$, N_W^o will be increased with, say, one unit. These steps are repeated till the following condition is achieved :

$$WE = (LE * TL_W) \pm \text{permissible tolerance.}$$

Then, the corresponding number WTG units fulfills the energy balance constraint and is taken as the final decision.

iii) The capacity (BS_W) of the battery accompanied, here, with the WTG is found using the same steps previously followed in estimating that accompanied with PVPS. So,

$$BS_W = BD_W + B_{CW} \quad \dots (6-a)$$

where $BD_W = B_W / \eta_B \quad \dots (6-b)$

It is the battery storage capacity required to accommodate the surplus energy of WES.

B_W is the surplus energy attainable during the rated speed period in the range of $V_{ci} < V_t < V_{co}$ given by :

$$B_W = \sum_{t=1}^{t=24} [W(t) - L(t) * TL_W] \quad \dots (6-c)$$

[When $W(t) > L(t) * TL_W$]

$W(t)$ is obtained on installing N_W units and TL_W as a penetration level.

On the other hand, B_{CW} is calculated from :

$$B_{CW} = (\text{critical loads}) * TL_W / \eta_B \quad \dots (6-d)$$

It is concluded that eqns (1), (2) & (3) are used with $TL_V = 1.0$ p. u. to find the component's sizes of PVPS/BS combination. However, to deduce components's sizes of WES/BS combination, eqns (4), (5) and (6) with $TL_W = 1.0$ p.u. have been applied.

Now, eqns (1) - (6) should be used with an arbitrary TL_V and its complement TL_W for sizing the heart units PVPS/WES/BS combination. The corresponding total BS capacity will have the summation of :

$$BS = BS_V + BS_W \quad \dots (7)$$

at the imposed TL_V & TL_W with and without PV-aided load management.

c) Economic Evaluation.

The energy cost figure, U , is chosen, here, as an index to differentiate between the imposed alternatives. It has been computed taking the effect of the meteorological conditions of the studied sites, Penetration levels, and with and without the application of the suggested load management strategy. Present and anticipated prices of SC modules, WTG units and BS are considered using the following expression [7] :

$$U = [(\text{Total capital investment of the energy combination}) (L.F)] + [\text{Annual O \& M costs}] / [(\text{Annual energy produced}) (\text{availability Factor})] \quad \dots (8)$$

Where:

$$L.F = r (1+r)^K / (1+r)^K - 1 = \text{charge rate}$$

r = Annual interest rate in P.U.

K = Amortization period in Year.

The total capital investment incorporates the costs of the wiring and control system, land area and interface devices in addition to the total hardware costs of the energy combination

3 RESULTS

3-1 Input and Output Particulars.

The proposed approach has been programmed to be run on an IBM personal computer (640KB). The systems's sizes with their corresponding economic results are printed out and summarized in Table (1) for the following input particulars:

- 1- Site : Two extremely located egyptian sites are selected. They are Mersa-Matruh (31.33°N) and East-oweinat (22.9° N).
- 2- Solar Radiation: The horizontal global levels were recorded continuously throughout the days of recent five years. They had been published in Ref. [8]. They are averaged and plotted in Fig. 3 (a & b) for representative months of summer and winter seasons and modified by the aid of methods mentioned in Refs. [9 & 10] resulting in the average daily radiation profile at the monthly best tilt angle for our sites.
- 3- Wind speed: Again, the hourly speeds had been collected and published in Ref. [9] for both sites covering all year's days. The average values are drawn for two representative months in Fig. 3 (a & b).
- 4- Load Demand: Two daily industrial load profiles are constituted representing its hourly variation for the summer and winter seasons. Their specifications are mentioned in the Appendix.
- 5- Energy Combinations Researched: Their technical and economical particulars are stated indetail in the Appendix.

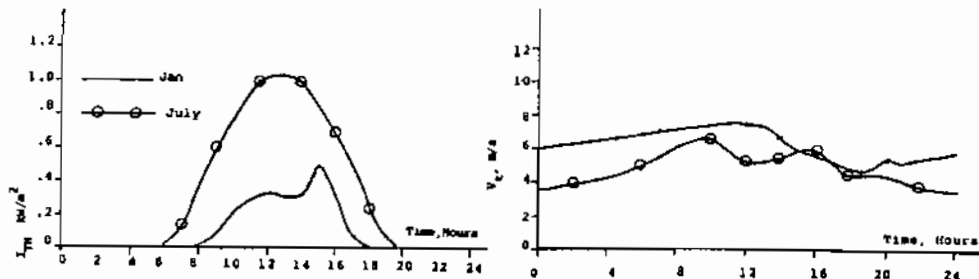

Fig .3-a Horizontal Solar Radiation, I_{TH} , and Wind Speed Profiles recorded for Nersa - Matruh Site.

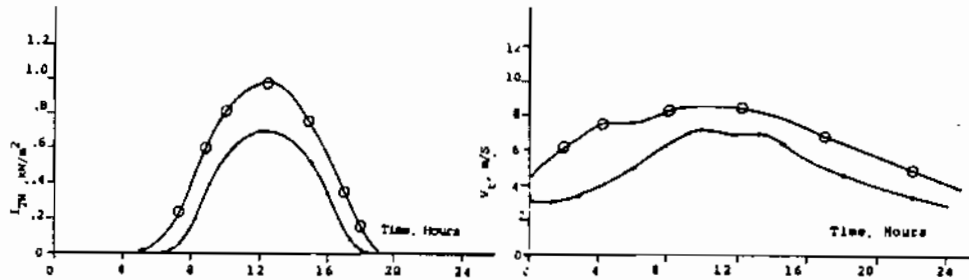

Fig .3-b Horizontal Solar Radiation, I_{TH} , and Wind Speed Profiles recorded for East - Oweinat Site.

Table (1) Sizes of Energy combinations on Applying Energy Balance Technique for Distinctive Penetration Levels.

Energy Combination	TL_V	TL_W	Nersa - Matruh							East-oweinat				
			S_1	No. of Modules	No. of Parallel Strings	BS, kWh		N_M	S_2	No. of Modules	No. of parallel strings	BS, kWh		
						After LM	Before LM					After LM	Before LM	
P.U	P.U	M_H	m^2					m^2						
PVPS/ BS	1.00	0.0	0.0	35620	23970	1410	5352	11390	0.0	3140	21111	1243	2900	11400
PVPS/ MES/BS	0.75	0.25	4	21927	14755	868	1310	10355	3	2064	13906	818	390	10180
	0.50	0.50	8	14046	9452	556	460	4500	5	1244	8361	493	174	6813
	0.25	0.75	12	6088	4097	241	0.0	4832	7	4471	3009	177	0.0	5400
MES/ BS	0.00	1.00	16	0.0	0.0	0.0	0.0	4100	9	0.0	0.0	0.0	0.0	7800

Each string consists of 17 modules and gives 4.98 Amp. at 416.5 VDC, 95 VAC (MPP). Each MPP Unit gives 200kW at Rated wind Speed, 4160 VAC, 50 HZ .

3.2 Quantitative Analysis and Discussion:

a) Geographical sitting and seasonal Effects.

In this Section, the demand and generation output profiles are demonstrated and analyzed with multiple conditions.

Fig. 4 shows, for the aforementioned egyptian locations, these patterns for equal penetration levels of intermittent systems i.e. $TL_v = TL_w = 0.50$ and summer and winter seasons. The shown sizes are found by satisfying the energy balance constraint.

With Mersa - Matruh site, Fig. 4. a displays an output of total peak of 2.0 MW while 1.81 MW is its value on installing the same energy combination in East - Oweinat (Fig. 4. c.). The fluctuation in the output of WTG sited in Mersa - Matruh impacts pronoucnly the resultant as displayed in Fig. 4.b. However, for East - oweinat, the total output profile behaves nearly like the solar radiation variation (Fig. 4- c & d). The followings are the main features of these profiles:

Season	Item	Site	
		Mersa - Matruh	East-Oweinat
Summer	Total Peak, MW	2	1.81
	Fluctuation in Total output, MW	(2 - 1.65 - 1.81)	No
	Lowest Output Level, MW .	0.18	0.34
Winter	Total Peak, MW	1.41	
	Fluctuation in Total output, MW	(1.41 - 1.23 - 1.48)	No
	Lowest Output Level, MW	0.35	0.17

Outof these details, it is clear that no output fluctuations will be experienced on installing both systems at East-oweinat. The seasonal characteristics influence the total peak and the lowest output level especially with Mersa - Matruh in the Northwest of EGYPT.

b) Impact of Composite Penetration Levels on Output Behavior.

Shown in Fig. 5. are the output patterns for two levels of penetration and summer season. The problem has been solved for the investigated sites. With the energy combinations located in Mersa - Matruh, Fig. 5-a depicts the case of $TL_v < TL_w$ which results in appreciable fluctuations in the total output. This observation can be ascribed by the considerable effect of fluctuated WTG output that results due to its high penetration.

On the contrary, Fig. 5-b reveals the total output having a quasi-smooth variation similar in shape to the positive half of a sinusoidal waveform. It occurs when $TL_v > TL_w$ which has led to very low total output levels in the night and earlier morning regions. This result is expected, here, since we have only the WTG output during these periods which again have low penetration level. Therefore, the need is substantial for suggesting and applying a load management strategy to modify the load demand in the foregoing periods.

Fig. 5-c and Fig. 5-d exhibit the output behavior but with the energy systems being sited in East-Oweinat. As a general of notice, the total output has a profile of smoothest shape since the fluctuations of the WTG output are not appreciable for this location. The case is better with $TL_w < TL_v$ as shown in Fig. 5.d. So, the principal characteristics of these curves can be tabulated in Table (2-a) which involves also those of Fig. 6.

Moreover, the individual and total output of both systems are instituted under the effect of winter circumstances taking the same penetration levels. Table (2-b) summarizes the main features of their daily behavior.

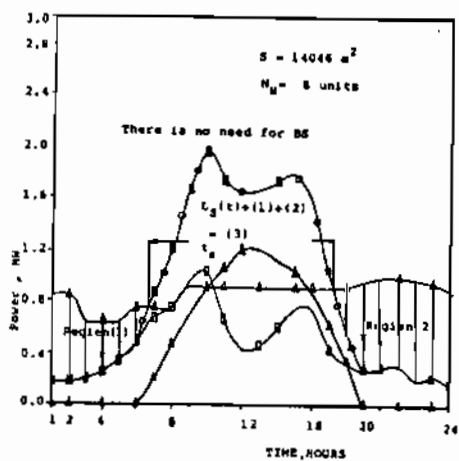

Fig.4-a Mersa - Matruh Site in Summer.

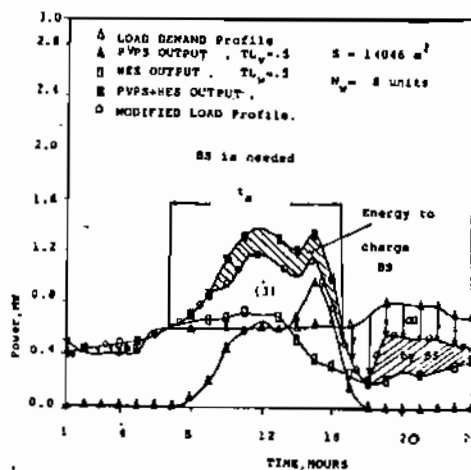

Fig. 4 - b Mersa - Matruh Site in Winter.

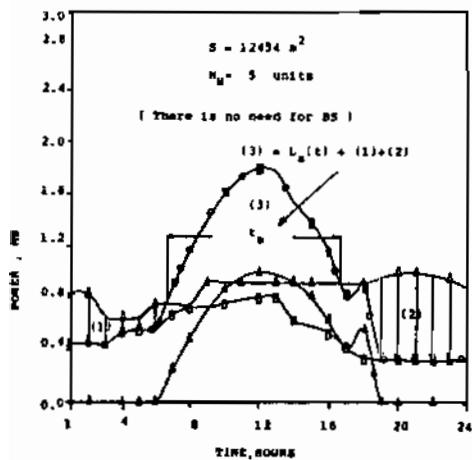

Fig. 4 - c East - Oweinat in Summer .

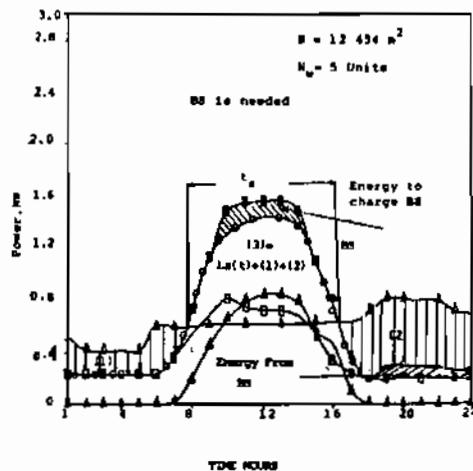

Fig.4 -d East - Oweinat site in Winter.

Fig. 4 Load Demand , PVPS Output, WES Output, PVPS + WES Output and Modified Load Profiles, Mersa - Matruh and East - Oweinat sites, $TL_V = 0.5$, $TL_W = 0.5$ (PVPS / WES/ BS Energy Combination)

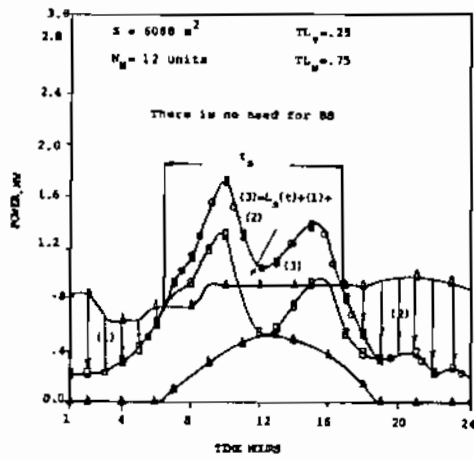

Fig. 5 - a Mersa - Matruh in Summer.

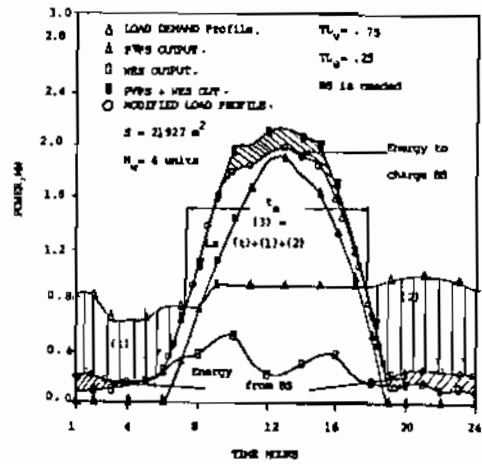

Fig.5 - b Mersa - Matruh also in Summer.

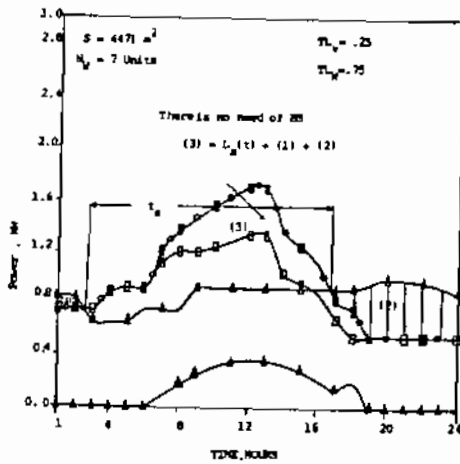

Fig 5-c East - Oweinat in Summer.

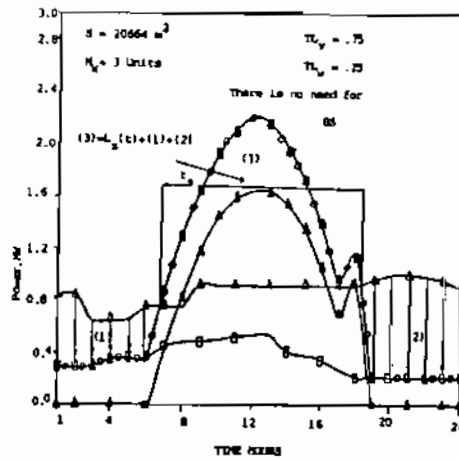

Fig.5-d East - Oweinat in Summer.

Fig. 5 Load Demand, PVPS Output, WES Output, PVPS+WES Output and Modified Load Profiles, Mersa - Matruh and East - Oweinat Sites (PVPS/WES/BS Energy combination)

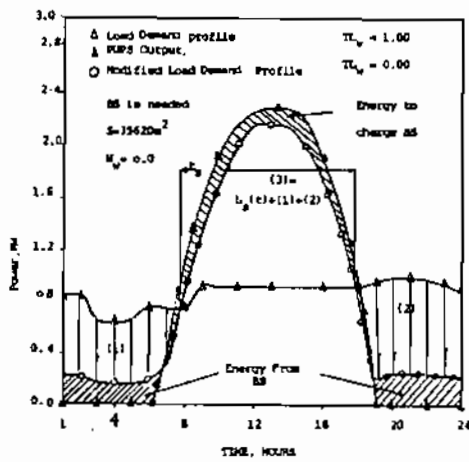

Fig. 5-a PVPS/BS Energy combination output, Matruh - Matruh, Summer.

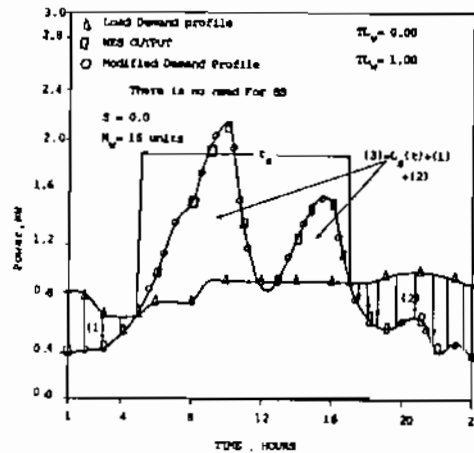

Fig. 5-b MES/BS Energy combination output, Matruh - Matruh, Summer.

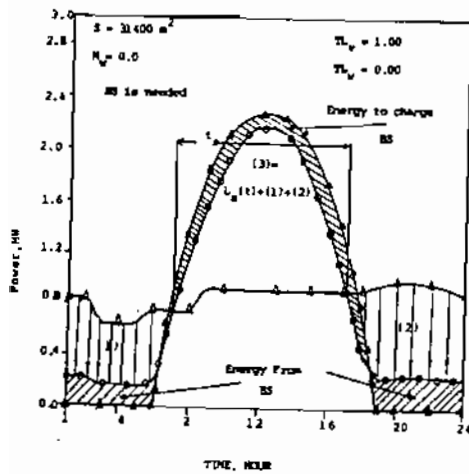

Fig. 5-c. PVPS/BS Energy combination output, East - Dweinat, Summer.

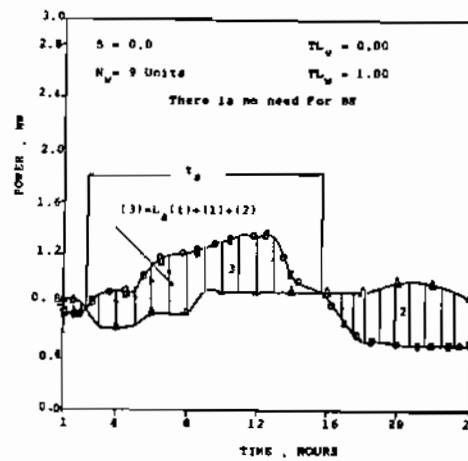

Fig. 5-d MES/BS Energy combination output, East - Dweinat, Summer.

Table (2-a) Fluctuations in Total Output in Summer Season
(Fig. 3 & 4).

Item	$TL_v =$ $TL_w =$	0	0.25	0.75	1.0
		1.0	0.75	0.25	0.0
Total Peak, MW	Mersa Matruh	2.15	1.75	2.18	2.18
	East- Oweinat	1.38	1.74	2.18	2.18
Fluctuations in Total Output, MW.	Mersa- Matruh	(2.15-0.8-1.58)	(1.75-1.065- 1.45)	NO	NO
	East- Oweinat	NO	NO	(2.18-0.95- 1.17)	NO
Lowest level of Total output, MW.	Mersa- Matruh,	0.35	0.21	0.10	0.15
	East- Oweinat	0.55	0.53	0.20	0.15

Table (2-b) Fluctuations in Total output in Winter Season.

Total Peak, MW	Mersa- Matruh	1.10	1.19	1.80	1.97
	East- Oweinat	1.50	1.40	1.85	1.82
Fluctuations in Total Output, MW	Mersa- Matruh	(1.10-0.28-0.42 -0.38-0.49)	NO	(1.8-1.48-1.62)	(1.97-1.17-1.32)
	East- Oweinat	(1.5-1.24-1.25)	NO	NO	NO
Lowest level of Total Output, MW	Mersa- Matruh	0.50	0.25	0.30	0.28
	East- Oweinat	0.35	0.23	0.10	0.18

Out of the shown results the following conclusions are drawn :

- 1- Installation of an energy combination either in the northwest or Southwest of EGYPT with $TL_v > TL_w$ augments the total peak to a higher value compared with the case of $TL_v < TL_w$. This is correct throughout the year months.
- 2- No fluctuations in total output, except for too short periods, have been observed with an energy combination being erected at East-oweinat. This is attractive and facilitates the task of maximum power tracking and conditioning.

c) Application of a Proposed Load Management Strategy (LM).

Throughout the optimization process, it is intended, by the aid of constituting the daily total output profiles of the energy combination, (T.O.), to eliminate or reduce the BS to have a minimum capacity so that the following constraints should be satisfied:

- 1- Energy balance.
- 2- It is used only to cover totally or partially the lighting and critical loads because of the insufficiency of the T.O. mainly in the night and earlier morning (inclined dashed regions).

This goal is achieved, here, by reshaping the load demand profile to be similar to that of the total output of the energy combinations studied.

The intersection of the daily profiles of T.O. and load demand yields three regions. The regions (1) & (2) are distinguished by $T.O. < L(t)$. If the second constraint (2) is to be met, then the off-lighting and critical loads in (1) & (2) (vertical dashed lines) are shifted and will be power in the τ_c -interval (Region (3)) where $T.O. > L(t)$. Thus the output of a combination of PVPS and WES determines in a precise manner the appropriate level of load management. So, one can call it as a PV and WTG-aided load management. This, in consequence, eliminates complex examinations and computations to achieve this purpose. Table (3) tabulates the main characteristics of the modified load demand curves after managing the loads under the impact of effective conditions. The economic evaluation of the problem for distinctive levels of penetration is explained in Table (4). It clearly shows the hardware price effects before and after applying the previous strategy on the energy cost figure (U).

Table (5) tabulates the decremental change in U (ΔU) on managing the load. The result of having a high P.U. value of ΔU means that the LM has a sensible influence on U or in other word that the PVPS or WES do't play a significant role in this management at the considered penetration and prices. The reverse is correct that is the results of having a minimum ΔU (ΔU_{min}) means that these systems have maximum effect in executing such strategy and there is no substantial need for additional management.

On conclusion, the basic and well-known definition of load management will be altered in view of these results. The common definition of LM is that it is demand-side load shape modification strategy in which the main objective is the shift of energy consumption patterns to reduce contribution system peak. Now, it certainly differs since the primary objective with the intermittent power producers is the shift of energy consumption profiles to increase contribution to system peak. In other words, the load demand pattern should be modified to coincide with that of T.O.

For the researched egyptian sites, Table (6) summarizes the most economic penetration levels of the PVPS and WES with their sizes for distinctive SC, PC and BS prices. Fig. 7 depicts the arrangement of windfarm of WTG units to be installed at Mersa-Matruh site, EGYPT with economic penetration levels of $TL_w = 0.80$ and $TL_v = 0.20$ with present SCA and PC prices. In addition, the energy cost figure is estimated before and after managing the load. So, the following remarks and results can be drawn:

- 1- With the present prices of SC and PC, it is preferable to introduce the PVPS with a low penetration level and install a large number of WTG units (N_w). Moreover, East-Oweinat site is more economic than Mersa-Matruh.
- 2- With the hopeful prices of SC and PC, the results explain that the PVPS with a BS as a back-up supply is the most economic energy combination required to withstand the load demand.

Table (13) Characteristics of the modified load patterns produced on Applying LM Strategy For Different Penetration Levels.

TLy	TLy P.U	Mersa-Hatun			Winter			Summer			East-Owainat		
		L _p P.M	t _p	L _f P.U	L _p M	t _p	L _f P.U	L _p M	t _p	L _f P.U	L _p M	t _p	L _f P.U
1.00	0.00	2.1664	13	.4014	1.9744	15	.3170	2.1801	12	.3990	1.805	13	.4366
0.75	0.25	1.97	13	.4414	1.54	15	.4074	2.19	12	.3871	1.60	12	.3911
0.50	0.50	1.93	10	.4505	1.191	12	.5254	1.80	12	.4831	1.46	12	.4005
0.25	0.75	1.72	10	.5056	1.185	12	.5281	1.70	12	.5115	1.38	10	.4535
0.00	1.00	2.1081	10	.4125	1.1089	11	.5644	1.3452	11	.6464	1.471	10	.4253

Table (14) Energy cost figure . U, For PVPS /HES / BS Combinations at Different Penetration Levels.

TLy	TLy P.U.	Mersa - Hatun						East - Owainat					
		After		Before LM		After LM		Before LM		After LM		Before LM	
		C _g and C _{bc} = 8.50/M ² /P	50	15	50	15	50	15	50	15	50	15	50
1.00	0.00	.2230	.0136	.0162	.2300	.0148	.0203	.1986	.2000	.0116	.0130	.2004	.2100
0.75	0.25	.1620	.0282	.0290	.1650	.0301	.0352	.1380	.1381	.0208	.0210	.1400	.1450
0.50	0.50	.1330	.0455	.0460	.1340	.0472	.0514	.1030	.1033	.0291	.0292	.1050	.1080
0.25	0.75	.1000	.0628	.0630	.1020	.0640	.0663	.0553	.0566	.0318	.0318	.0566	.0600
0.00	1.00	.1131	.1370	.1131	.1370	.1153	.1441	.0700	.09402	.0700	.0940	.0720	.1013

* Applying a Proposed Load Management Strategy .

Table (5) Decremental Change in U. ΔU On Applying a load Management Strategy.

TL _v	TL _v	Hercas - Matruh				East - Ombinat			
		U %				U %			
		C _g =8.33/M _p		C _{pc} =8.5/M		C _g =8.33/M _p		C _{pc} =8.5/M	
P.U.	P.U.	C _B =8.15/kWh	50	15	50	15	50	15	50
1.00	0.00	3.14	4.00	8.82	25.30	4.56	5.00	15.52	45.38
0.75	0.25	1.85	4.30	6.74	21.40	1.45	3.10	10.58	29.52
0.50	0.50	1.52	3.00	3.74	11.74	1.94	4.55	6.53	15.41
0.25	0.75	2.00	3.00	2.00	5.24	2.40	6.00	4.09	13.84
0.00	1.00	1.95	5.20	1.95	5.28	2.85	7.80	2.86	7.80

** $\Delta U = 100 (U_B - U_A) / U_A$
 U_B : Before Managing the load.
 U_A : After Managing the load.

Table (6) Most Economic TL_{v0} & TL_{v0} For PVPS /HES/RS Energy combinations.

TL _{v0}	C _g = 8.33/M _p , C _{pc} = 8.5/M								C _g = 8.27/M _p , C _{pc} = 8.81/M							
	Hercas - Matruh				East - Ombinat				Hercas - Matruh				East - Ombinat			
	After LM*	Before LM	After LM*	Before LM	After LM*	Before LM	After LM*	Before LM	After LM*	Before LM	After LM*	Before LM	After LM*	Before LM	After LM*	Before LM
C _B =8.15/kWh	50	15	50	15	50	15	50	15	50	15	50	15	50	15	50	
N _g PV	.20	.20	.20	.20	.15	.15	.15	.20	1.0	1.0	1.0	1.0	1.0	1.0	1.0	
N _g HES	.80	.80	.80	.80	.85	.85	.80	.80	0.0	0.0	0.0	0.0	0.0	0.0	0.0	
s ₀ ²	1258	1225	1225	1225	1180	1426	1426	1426	287	25820	79670	25820	25820	2408	2408	
no. of Modules	2536	2536	2536	2536	2252	1752	1752	2096	22970	22970	22970	22970	2212	2212	2212	
no. of Parallel Strings	208	208	208	208	78	78	78	173	1418	1418	1418	1418	1241	1243	1243	
N ₀	13	13	13	13	5	5	5	7	0.8	0.8	0.8	0.8	0.8	0.8	0.8	
RS Capacity, kWh	0.0	0.0	0.0	0.0	0.0	0.0	0.0	0.0	1120	1120	1120	1120	1120	1120	1120	
U, \$/kWh	.0956	.0960	.0960	.0960	.0930	.0926	.0926	.0926	.0936	.0936	.0936	.0936	.0936	.0936	.0936	

*Applying Proposed Load Management Strategy.

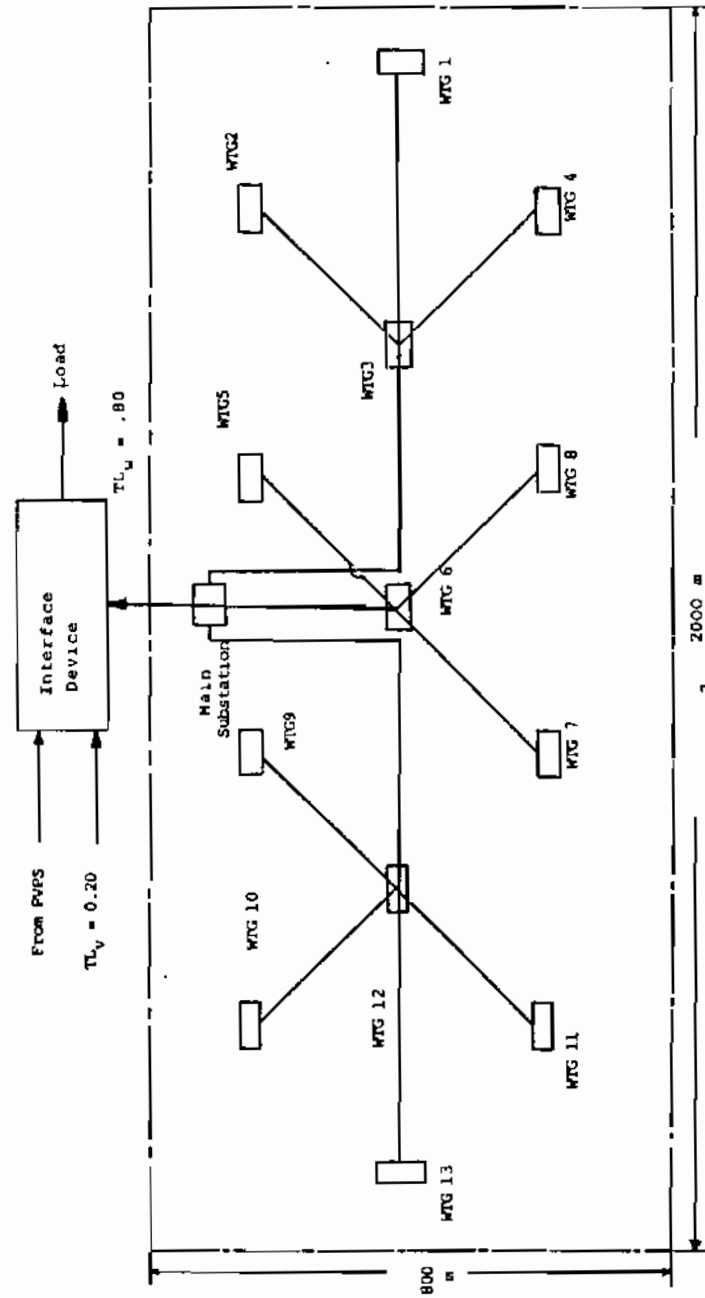

Fig.7 Arrangement of Wind Farm of 13 WTG units to be installed in Mersa - Matruh Site (EGYPT) With most economic Penetration levels of $TL_y = 0.80$, $TL_x = 0.20$.

- 3- The load management affects principally the BS capacity . It is omitted with the present prices while with the anticipated ones, the capacity has been reduced by a percentage up to about 50%. The last result has been obtained on using PVPS only as a power producer.
- 4- The results demonstrate to what extent the use of renewable energy combination is economically attractive in the light of the meteorological egyptian conditions. Lowest cost figures are obtained on applying the suggested load management strategy and anticipated prices. They are \$ 0.0136 and \$ 0.0116 for Mersa-Matruh and East-Oweinat respectively.

4 CONCLUSION

The followings are the salient conclusions that can be drawn from this paper:

- 1- Integrating and installing PVPS and WES in sites like the egyptian ones is very useful and indispensable for meeting the load requirements.
- 2- It is viable to use actual hour-by-hour data since they accommodate accurately all seasonal variations of the locations.
- 3- The most economic energy combination very much depends on :
 - a) The essential assumptions
 - b) Type of data and approach of sizing the SCA, WTG and BS subsystems.
 - c) Possibility of applying a LM strategy.
 - d) Role of BS and its capacity with its operation time.
 - e) Prices of the hardware components in the present and future times.
- 4) The demand and generation output profiles are deduced and analyzed for distinctive penetration levels of both PVPS & WES hypothetically installed at Mersa-Matruh and East-Oweinat in EGYPT.
- 5) With East-Oweinat and $TL_v < TL_w$, the total output has a profile of smoothest shape since the fluctuations in WTG output are not appreciable for this location. The result is better with $TL_w < TL_v$. This is practically attractive and thus facilitates the task of maximum power tracking and conditioning.
- 6- The battery storage is eliminated or reduced having a minimum capacity by applying what we call and propose here as PVPS & WES-aided load management. Thus, the daily load demand profile has been reshaped so that it becomes similar to that of the total output of the energy combination studied.
- 7- Table (6) demonstrates the most economic penetration levels of the PVPS and WES with their sizes and various hardware components costs. The impact of applying the LM strategy is explained and quantitatively analyzed

With the present prices of SCA and PC, it is the most economic to introduce a PVPS with a low Penetration level and install a large number of WTG units. East-Oweinat is more economic than Mersa-Matrach. On contrary, with the hopeful SCA & PC prices, PVPS + BS as a back up supply is the most economic combination.

REFERENCES

- [1] R. Ramakumar, P. Sudhakara and K. Ashenayi, "A Linear Programming Approach to the Design of Integrated Renewable Energy Systems For Developing Countries," IEEE Vol. EC-1, No. 4, December 1986, pp. 18-24 .
- [2] Benjamin Y.H. Liu and Richard C. Jordan, "Daily Insolation on Surfaces Tilted Toward the Equator," ASHRAE Journal, October, 1961, pp. 53-59 .
- [3] S.A. KLEIN, "Calculation of Monthly Average Insolation on Tilted surfaces," Solar Energy, Vol. 19, pp. 325-329, 1977 .
- [4] G.E. Jorgensen, M Lotker, R.C. Meier and D. Brurley, "Design Economic and System Considerations of Large Wind-Driven Generators", IEEE, Vol. PAS - 95, No. 3, May/June 1976, pp. 870-878 .
- [5] Gary L. Johnson, "Wind Energy Systems" Book, Prentice-Hall, INC, Englewood Cliffs, N.J. 07632, USA, 1985 .

- [6] Gary L. Johnson, "Economic Design of Wind Electric System" IEEE, Vol. PAS-97, No. 2, March/April 1978, pp. 554-562.
- [7] R. Ramakumar, "Renewable Energy Sources and Developing Countries," Vol. PAS - 102, No. 2, February 1983, pp. 502-510 .
- [8] "1986's Hourly Global Insolation Report of Egyptian Sites", Meteorological Station of Arab Republic of EGYPT, 1987.
- [9] "The Available Wind Data in EGYPT", Report, Prepared by A. Mobark under the Contract of "Development of Wind-solar Power Generation System for Rural Areas in EGYPT", With Ministry of Electricity and Energy of EGYPT, 1982 .
- [10] "Design of a Photovoltaic Central Power Station", Contract Report, SAND 82-7149 Unlimited Release UG- 63-a, Marietta corporation Denver, Co., February, 1984.
- [11] P.L. Pulfrey, "Photovoltaic Power Generation", Book, Van Nostrand Reinhold Company, 1978 .
- [12] Adam Pintz, R. Kasuba, and J. Spring, "Conceptual Design of a Fixed-Pitch Wind Turbine Generator System Rated at 400 Kilowatts", Report, DOE/NASA/0006-1, NASA CR-174877, June, 1984 .

APPENDIX

a) Load Demand Pattern

Particulars	Season	
	Summer	Winter
Daily Energy, ⁽¹⁾ LE, MWh	20.87	15.02
Peak, L_p , MW	1.00	0.82
Peak Load Starting Instant, t_p	20.00	19.00
Load Factor, ⁽²⁾ P.U.	0.87	0.76

(1) Constant either before or after Managing the load.

(2) Before Managing the load.

b) SCA [10]: cells: Dendritic Web, silicon, Noct: 44°C, Module size: 1.32 x 1.32 m, Extruded Al frame, EVA pottant, 0.32 cm Full-Tempered glass, 0.13 mm craneglass, mylar backing. Module Aperture = 1.486 m² $\eta_c = 0.142$, $\eta_{\text{module}} = .122$, $V_{oc} = 24.5 V_{dc}$, $I_{sc} = 9.52A$, $V_{mp} = 19.91 V_{dc}$, $I_{mp} = 8.98. A$, $P_{mp} = 178.8 W$, at 1000 W/m², AM1.5, 29°C

c) PC: $\eta_{pc} = 0.95$ (Involving Inverter and switch).

d) BS [11]: $\eta_B = 0.80$, sodium-sulfur and lead-acid.

e) WTG [12]: Turbine: A horizontal axis, propeller type, constant speed, Rotor Diameter = 40.35 m, Rotor Ground clearance = 15.2 m, Rotor speed = 36.9 RPM, $V_r = 7.7$, $V_{ci} = 3.8$ and $V_{co} = 16.4$ m/s at 17.7 m. Mechanical Transmission: $\eta_m = 0.96$, synchronous type Electrical Generator, $\eta_g = 0.93$ at UPE, Rated power = 200 kW, $f = 60$ HZ, Terminal voltage = 4160 V_{ac} .

f) Economical Particulars: $C_s = \$ 3.5/W_p$ (present price) and 0.2 \$/Wp (anticipated price)*, $C_{pc} = 0.5$ \$/W and 0.01 \$/W*, $C_B = \$ 15/kWh$, Sodium-sulfur and \$ 50/kWh. Lead-Acid Types, WTG Price = \$ 1000/kW, [12], Control Devic Price = \$ 800/WTG unit, Microprocessor Price = \$ 11000, Yearly O & M = 0.15 of Annual Levelizing Cost for WES/BS Combination and = 0.05 for PVPS/BS Combination. Land area Price = 0.5 \$/m². * Within Future 10 Years, [9] .

