

## ON THE THERMODYNAMICS OF DUAL PURPOSE POWER DESALTING PLANTS WITH GAS TURBINE

M.A. DARWISH\* , A. ELHADIK\*\* AND A. DAYOUB\*

\* Mechanical Engineering Department, Kuwait University

\*\* College of Technological Studies, Kuwait.

(Received May. 10, 1987, accepted June 1987)

خلاصة :

تم اجراء التطور الحديث في الدورات الحرارية المركبة لمحطات القوى والتي تحتوي على توربينات غازية وبخارية . اثبت التحليل الحراري بتطبيق القانون الاول والثاني على الدورات الحرارية للتوربينات الغازية ان حوالي 30% من الطاقة القابلة في الوقود تفقد مع الغازات العادمة . هذه الطاقة القابلة يمكن الاستفادة منها بتحويلها الى شغل او انتاج حرارة مباشرة . الحرارة المسترجعة من غازات العادم للتوربينات الغازية تستخدم نسبيا في توليد البخار عند الضغوط المرتفعة . وهذه الدورة الحرارية المركبة ترتفع كفاءتها الحرارية لتصل (من 40 الى 50%) كما انه باستخدام تلك الحرارة المسترجعة يمكن توليد بخار عند ضغوط منخفضة وذلك لتحلية المياه المالحة بواسطة التبخير السريع المتعدد المراحل . ايضا تم استعراض الوحدات المركبة من التوربينات الغازية او التوربينات الغازية والبخارية مع تحلية المياه بواسطة التناضح العكسي او التبخير السريع المتعدد المراحل اثبت التحليل الحراري ان هذه الوحدات يمكن ان تعطى استخداما امثل للحرارة القابلة من الوقود المستخدم .

**ABSTRACT-** Recent advances in gas turbine cycles and combined gas/steam turbine cycles are presented. First and second law analysis of gas turbine cycles is presented and shows that substantial available energy (up to 30% of fuel availability) is carried out by gas turbine exhaust gases. This available energy can be utilized for further heat to work conversion or for direct process heating. Heat recovered from gas turbine exhaust gases in heat recovery steam generator (HRSG) can generate relatively high pressure steam to be supplied to Rankine steam power cycle to form gas/steam power cycle of high efficiency (40-45%). Steam can be generated at low pressure in the HRSG for direct supply to the brine heater of a multistage flash (MSF) desalting system. Possible combination of simple gas turbine cycle or combined gas/steam cycle with reverse osmosis or MSF sea water desalting systems are presented and evaluated. The evaluation indicates that most of these combination are more superior than combination with steam power plants from energy view points.

### INTRODUCTION

While prospects to improve the efficiency of steam power plants (either conventional or combined with desalting system) are very limited, wide prospects exist to improve the gas turbine cycles by better utilization of fuel availability. Twenty years ago, an open gas turbine cycle was considered a low efficiency machine with a typical efficiency around 20%, maximum gas temperature at the turbine inlet (TIT) of 800°C, and pressure ratio 10. Recent advances in gas turbines technology improve the efficiency to more than 30% by increasing the TIT to the range of 1000-1200°C with blade cooling and increasing the pressure ratio up to 30. Table (1) gives the characteristics of some commercially available gas turbines. The table shows that the efficiency and work output of a gas turbine are strong function of TIT. An increase of 45°C in TIT would increase the efficiency by 1.25 to 1.5% and work output by 10%.

The direct expansion of the high temperature combustible gases in a gas turbine avoids the irreversibilities (or availability destruction) associated with the heat transfer process between the combustible gases and working fluid as steam in steam generators. The ratio of air stream availability increase to fuel availability in the combustion chamber of a gas turbine is in the order of 70% (compared to maximum 44% in modern type steam generators). This can be shown by calculating the availability losses in the combustion chamber of a typical gas turbine using n-octane,  $C_8H_{18}$  liquid fuel, 700°K inlet air temperature to the combustion chamber, 230% excess air, 1400°K air temperature leaving the combustion chamber, 0.0195 fuel to air ratio, and 5% thermal losses. The reaction equation

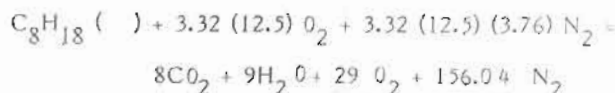

is used to calculate the entropy increase/kg fuel. This entropy increase is equal to 42.3 KJ/kg.K and the ratio of the availability increase in the air stream to the fuel availability is equal to 70% (with 5% thermal losses). The decrease of the temperature leaving the combustion chamber (or the decrease of TIT) will increase the availability destruction and lowers the second law efficiency of the combustion process.

Beside the 30% of fuel availability loss in the combustion chamber of a typical gas turbine, about 30% of fuel availability is converted to useful work. The system shown in Fig. 1, with a typical data similar to EL-Seuz gas/steam combined plant [1], is considered a reference plant for this study. The plant has 3 gas turbines (each produces 51.4 MW with 30% first law efficiency) and combined with a condensing steam turbine which produces 79 Mw. The total power production is 233.2 MW with overall efficiency of 44%. The isentropic efficiency of the gas turbine and compressor were assumed equal to 0.87 and .85 respectively with pressure ratio 11. The second law efficiency of compressor and turbine were calculated and found equal to 90.4% and 92.3% respectively. This gives availability destruction in both gas turbine and compressor with respect to the fuel availability (including 5% thermal losses in the turbine) equal to about 10%. This brings the availability balance carried out by the exhaust gases and other unforeseen losses upto the order of 30% of the fuel availability.

#### HEAT RECOVERY STEAM GENERATOR FOR HRSG

The exhaust gases from the gas turbines have relatively high temperatures and are carrying up to 30% of the fuel availability. The availability of the exhaust gases can be utilized for further heat to work conversion or just for heating purposes. The exhaust gases heat can be recovered in a heat recovery steam generator HRSG (i.e. boiler). The HRSG is a series of heat exchanger using the exhaust gases to raise a feed water temperature to its boiling temperature, evaporates it and superheats it. Three types of HRSG are usually used, namely unfired, supplementary fired and fully fired heat recovery steam generators. The unfired HRSG steam production rate is completely dependent on the gas turbine exhaust gases flow rates and temperature. The auxiliary fired HRSG has an auxiliary burner to increase the temperatures of the exhaust gases upto 900° C; and can modulate the steam production capabilities irrespective of the gas turbine operational modes. The fully fired HRSG admits only part of the gas turbine exhaust gases which is required to generate the desired amount of steam. Unfired and auxiliary fired HRSG only are considered here.

The steam output from the HRSG can be generated at low pressure for direct use as a process heat for desalting plants, driving absorption cooling machines, or other heating purposes. The steam can be generated also at elevated pressures and temperatures for: (i) expansion in a condensing turbine of a Rankine power cycle, or (ii) expansion in a turbine with partial (or total) bleeding to a desalter

before the condensing conditions. When the steam generated by gas turbine exhaust gases in HRSG is fed to a steam turbine of a Rankine cycle, a gas/steam turbine combined cycle of relatively high efficiency (40-45%) is formed as the system shown in Fig. 1. Table 2 gives the availability of the exhaust gases, work output from the Rankine cycle when combined with some of the commercially available gas turbines, and the expected efficiency of the combined steam/gas turbine cycle.

One of the parameters affecting the design of the HRSG is the temperature difference between the hot gases and the water steam at the pinch point. This point is located where the hot gases is at the evaporator-economizer interface as shown in Fig.2.a. At this point, the two streams have the most close temperatures. Typical design value of temperature difference at the pinch point is 20-30° C. So the gas leaving the evaporator is at temperature exceeding the steam saturation by the pinch point temperature difference. Consequently, the gas temperature and enthalpy drops of the gas turbine exhaust gases depend on the generated steam pressure (and saturation temperatures). Lowering this steam pressure increases the gas temperature drop and increases the boiler effectiveness. The relatively low pressure steam generated in HRSG (i.e. high boiler effectiveness) is suitable to supply the process heat required by the MSF desalting plants. Typical steam pressures required for the MSF plants are: 1 bar for top brine temperature (TBT) of 90° C (i.e. polyphosphat treatment) or maximum 3 bar for TBT of 120 C (i.e. acid treatment).

Steam generated in HRSG is supplied to steam turbine to produce more work when higher power to heat (or desalted water output) ratio is required. If this steam is supplied at low pressure, low steam cycle efficiency is resulted (but with high boiler effectiveness) and vice-versa. The measure to improve the steam cycle efficiency (i.e., raising the steam pressure) would reduce the HRSG effectiveness. This conflict is solved by using two steam pressure levels in the HRSG in order to give high pressure for high steam cycle efficiency and low pressure to keep high effectiveness recovery boiler as shown in Fig. 2b. Economic analysis is usually required to evaluate the benefits of adding steam power cycle (for more power generation) relative to the incremental increase in investment compared with cycle providing heat directly to the desalting plant.

The terms used to rate the HRSG are:

1- Effectiveness, E, defined by the fraction of heat content of the exhaust gases that is captured by the water/steam

$$E = \frac{m_g C_g (t_i - t_e)}{m_g C_g (t_i - t_o)} = \frac{t_i - t_e}{t_i - t_o}$$

where  $t_i$  and  $t_e$  are exhaust gases temperature at the inlet and exit of HRSG respectively,  $t_o$  is the environment temperature,  $m_g$  and  $C_g$  are the mass flow rate and the specific heat of the gases.

2- The second law efficiency defined by

$$= \frac{m_s (a_{se} - a_{si})}{m_g a_{gi}}$$

where  $m_s$ ,  $a_{si}$  and  $a_{se}$  are steam flow rate and specific availability at HRSG inlet and outlet respectively, and  $a_{gi}$  is the exhaust gases specific availability at the HRSG inlet.

There is a minimum exhaust gas temperature from the HRSG to prevent low temperature corrosion. If the gas inlet and exit temperatures are 526° C and 155° C respectively, the feed water to the boiler is at 130° C and steam outlet conditions (to the steam turbine of the reference plant) are 475° C temperature,

and 43.2 bar pressure, then the effectiveness  $E$  is equal to 0.74 and second law efficiency  $\xi$  is equal to 0.724. When the HRSG is supplementary fired the exhaust gases temperature is raised to 800° C while all conditions remain the same, the effectiveness,  $E$ , and second law efficiency  $\xi$  are 0.832, and 0.65 respectively. The data of the reference plant is given in table 3.

#### COUPLING OF GAS (OR GAS/STEAM) TURBINE POWER PLANTS WITH DESALTING PLANTS.

Desalination became the main source of fresh (potable) water supply in many parts of the Arabian Peninsula where more than 84% of the desalted seawater-world wide-is produced. Multi stage flash (MSF) and reverse osmosis (RO) are the main sea water desalting systems used in this area. Most of large MSF desalting plants are coupled with steam power plants to satisfy the simultaneous needs of electric power and desalted water. Another reason for coupling is the decrease of the primary energy demand from (210-310 KJ/kg product water) for single purpose MSF system to (100-160 KJ/kg product water) for dual purpose steam plants. At the same time, large portion of the electric power production is (or planned to be) produced by gas turbines. Only few cases exist in the Gulf area where desalting plants are coupled with gas turbines. The coupling of desalting plants with gas turbines seems interesting because of the recent developments in the gas turbines and the combined gas/steam cycles high performance and the fact that free thermal energy is offered by the gas turbine exhaust gases. It may be noted that energy cost represent about 60% of the total cost of the desalting seawater in 1980, Wood [2], in oil importing countries. (The energy costs in most Gulf countries are subsidized by governments and do not represent the real costs). Since coupling of desalting systems with gas turbines is not familiar, some basic schemes for such coupling are presented here with emphasis on MSF and RO technologies. The preference of one scheme over another would depend on many factors such as the required power to water ratio, cost of fuel energy charged to the desalting process, capital costs, and local requirements. The application of each scheme is demonstrated on the reference plant given in Fig. 1. Desalination plants of same characteristics are chosen with each scheme for meaningful comparison at the ends. These desalting plants are:

- (i) Multi stage flash (MSF) units having: (a) gain ratio (product/steam ratio) equal to 8 when operated at top brine temperature (TBT) of 90° C and supplied with steam of 100° C saturation temperature, or  
(b) gain ratio 8.77 when TBT is 110° C and the saturation temperature of the supply steam is 120° C. This is a typical case of Doha West MSF desalting plant with 24 stages and dealing with sea water of 45000 ppm TDS.
- (ii) Reverse Osmosis (RO) desalting units with energy consumption of: (a) 10.5 Kwh/m<sup>3</sup> product when dealing with sea water of 45000 ppm to produce product of 1000 ppm in a single stage ; or  
(b) consuming 13 Kwh/m<sup>3</sup> product when dealing with the same seawater to produce product water of 500 ppm in two stages. This is a typical case of Jeddah, RO sea water desalting plant in Saudi Arabia that produces 3.2 mgd. The estimation of the energy consumption of the RO Jeddah plant data are given in reference [3] and reproduced in Fig. (3). Now the suggested schemes are given in the following sections.

#### 1- COMBINED GAS/BACK PRESSURE STEAM TURBINE WITH MSF DESALTING SYSTEM.

This scheme, as shown in Fig. 4, is the most efficient scheme in utilizing energy. It permits the proper use of the higher temperature part of the waste heat in raising relatively high pressure and temperature steam and expands it to give work before its supply to the desalter. The steam is expanded in the steam

turbine to a back pressure of 2.1 bar before its supply to the desalting plant. The supply of all expanded steam to the desalting plant cancels the need for the condenser and its associated civil works, and the need to huge and expensive low pressure part of the steam turbine. This reduces the cost of both mechanical equipment and civil work. The use of the back pressure turbine reduces the steam turbine output (when compared with condensing steam turbine, case of Fig. 1) but desalted water is produced. The main data of the reference plant when the condensing turbine is substituted with back pressure turbine to allow the addition of MSF desalters are given in table 3. The table shows that the mechanical work loss due to bleeding of steam to the desalter is equal to about 38 KJ/Kg of desalted water product. The desalting plant is charged the fuel cost corresponding to power decrease due both bleeding and power consumption by the MSF plant.

## 2- COMBINED GAS/CONDENSING-EXTRACTION STEAM TURBINE WITH MSF-SYSTEM

If the steam turbine power output requirement is ranged between the case of condensing power plant (i.e. 78.9 MW in the reference plant) and that of back pressure turbine case (52.4 MW), a condensing steam-extraction turbine can be used. In this case, shown in Fig. 5, only part of the steam expanding in the turbine is bled to the desalter (at pressure of 2.1 bar) while the rest of steam continues its expansion to the condensing condition. Consequently, a condenser is required (but smaller in size than the straight forward condensing turbine case) and less desalted water is obtained. The ratio of the bled steam to the steam inlet to the turbine is the main factor affecting the steam turbine power output and the desalting capacity as shown in Fig. 6.

In cases when no power output is needed beyond the gas turbines power output and all the energy extracted from exhaust gases is utilized in desalting water, two possibilities exist.

## 3- COMBINED GAS/BACK PRESSURE STEAM TURBINE WITH HYBRID RO AND MSF DESALTING SYSTEMS.

The back pressure steam turbine arrangement discussed before is used here. While the steam leaving the back pressure turbine supplies MSF desalting units, the steam turbine power output operates reverse osmosis desalting units (see Fig. 7). The capacity of MSF units is the same as the case of the back pressure turbine discussed before. The capacity of RO system depends on the required product total dissolved solids (TDS). Usually an average total dissolved solids TDS under 500 ppm is required for the product from all involved desalting systems according to WHO (World Health Organization). Since the MSF desalter product is almost pure (less than 50 ppm), then a single stage RO units plant producing a product of 1000 ppm and have the same capacity of the MSF is usually used. The product of this one stage units is blended with the MSF unit product to give a mixture product having TDS equal to 500 ppm.

Another two stage RO units desalting plant with product of 500 ppm can be used to utilize the balance of the steam turbine power output. By using the power consumptions rates given before for the single and two stages RO systems, and the power outputs of the back pressure steam turbine for unfired and supplementary fired cases, the desalted water output would be 1739 kg/s (33 mgd) for unfired and 3010 kg/s (90.4 mgd) for supplementary fired cases as shown in Fig. 7, and tabulated in table 4.

It may be noticed here that if straight forward condensing steam turbine is used and all its power output should drive a two stage RO systems and the total desalted power output would be 1688 Kg/s (32 mgd) for unfired case and 2912 kg/s (55.19 mgd) for supplementary fired case. This is corresponding to power

output of 79 MW and 136.32 MW for unfired and supplementary fired condensing steam turbine respectively.

#### 4- GAS TURBINE WITH HRSG AND MSF SYSTEM.

In this case no more power, beyond the gas turbines output, is required. All exhaust gases energy is utilized in producing the low pressure steam required by the MSF system (see Fig. 8). So, the HRSG has a simple one stage pressure with no super heater section. This also cancels the steam turbine, condenser and all auxiliaries of the steam power cycle from the reference plant. The desalted water output from the MSF plant for this case is 1000 kg/s (18.95 mgd) for unfired HRSG or 1660 Kg/s (31.4 mgd) for supplementary fired HRSG. The mechanical energy consumption for the 18.95 mgd and 31.4 mgd are 14.0 MW and 23.24 MW respectively. This scheme low water capacity compared with that of back pressure turbine schemes reflects the fact that the relatively high temperature exhaust gas is used to generate low availability steam (and consequently low second law HRSG efficiency). The second law efficiency of the HRSG when the steam is supply directly to the desalter and to the steam turbine conditions are:

Condition		Water inlet Temp./Press. °C/bar	Steam out Temp./Press. °C/bar	Hot gases temp. inlet/outlet °C	ε
Supply to turbine	unfired			525/155	0.72
	S. fired	130/50	475/42.5	800/155	0.65
Direct supply to de- salter	unfired			525/155	0.40
	S. Fired	120/2.0	120/2.0	800/155	0.36

The decrease of the desalted water should be weighted against the extra cost of HRSG with superheater and two pressure levels, and the cost of the steam power plant.

#### 5- SINGLE PURPOSE DESALTING PLANT

An interesting situation, specially for Kuwait, is to use the gas turbine (with or without its combined steam turbine) to supply the net work with its power production at the peak demand time only. This time lasts only for few hours at small number of days during summer. Then the gas turbine power output can be devoted, most of the time, to operate a reverse osmosis desalting plant. This scheme would relief in the long run, the desalting producers from being dependent on the electric power producers to lower the specific fuel energy consumption of desalted water. The gas turbine power production of the reference plant (3x 51.4 MW) would be able to produce up to 3295 Kg/s (62.4 mgd) desalted water of TDS equal to 500 ppm from two stage RO plant. If the exhaust gases were used also to produce desalted water from MSF system (scheme 4), one and two stages RO plants can be used and the total product would be:

- (i) 1000 kg/s (18.95 mgd) from MSF plant
- (ii) 1000 Kg/s (18.95 mgd) from single stage RO plant, and
- (iii) 2188 kg/s (28.26 mgd) from two stage RO plant. The total plant production would be 4188 Kg/s (79.3 mgd). Similar calculation can be made with gas turbine combined with back pressure steam turbine and whole system is devoted to produce desalted water only. The total power production for scheme 2 with unfired HRSG is equal to 5034 kg/s (95.38 mgd) as shown in Fig. 9.

### SPECIFIC FUEL CONSUMPTION OF THE DESALTED WATER WITH DIFFERENT SCHEMES.

Among the important parameters in desalting sea water is the fuel energy consumption to produce a unit mass of desalted water, Q/D. The calculation of fuel amount (or cost) charged to the desalter when both power and desalted water are produced in one plant is not direct. One of the methods used to allocate the fuel charged to power production to water production is the availability method. This method can be illustrated by dividing the fuel consumption (or cost) between the power and water in accordance to the available energy consumed by each product.

The available energy content of the exhaust gases represents about 25% of the fuel availability. So, the gas turbines consume in producing power and other losses about 75% of the fuel availability while the 25% of the fuel availability is utilized in whatever produced beyond the gas turbines. If the exhaust gasses is utilized to produce only desalted water, then the ratio of charging the fuel consumption to the power production and production water should be 75/25. So for simple gas turbines, HRSG, and MSF arrangement (scheme 4), the 526 MW thermal energy input is divided to 394.5 MW to power production (actual  $\eta = 0.4$  not 0.30) and the balance 131.5 MW to desalted water. This gives the specific fuel consumption in KJ per kg of distillate product equal to 131.5 KJ/kg for thermal energy only. When combined gas/back pressure steam turbines are used with hybrid MSF/RO desalting system, specific fuel consumption for desalted waer is 75.1 KJ/kg. Other cases are tabulated in table 5 which compares the different schemes. The specific fuel energy, tabulated in table 5, for desalting water includes both thermal and mechanical energy consumptions.

### CONCLUSION

When the reference MSF desalting plant was combined with modern steam power plant in the first paper [4], the primary (fuel) energy consumption was calculated and shown equal to about 150 KJ/kg product. Combining the same plant with gas/back pressure steam combined cycle required fuel energy of 86.5 KJ/kg product only. A combination of MSF/RO system with the combined gas/steam cycle requires, even less fuel energy (about 75.6 KJ/kg product or 50% of the fuel energy required in dual purpose steam plants). In all presented combinations with gas turbines, except with direct use of recovered heat with and without supplementary firing to MSF system), the primary energy consumption is lower than in combination with steam cycle. The use of back pressure steam turbine and unfired HRSG is the most efficient combination. Beside the efficiency of proposed combinations, they give more flexibility in changing power to water ratio and loose restrictions on operation of both desalter and power producers turbines.

### REFERENCES

- 1 G. Crisitina, D. Mettler El Seuz 230 MW Combined Cycle Plant Improves Mexico's Efficiency. BBC (Brown Boveri Company) Publications on Cogeneration.
- 2 F.C. Wood, The Changing Face of Desalination-A Consulting Engineer's View Point. Desalination (1982), Vol. 42, 1, 17-26.
- 3 A.B. Riedinger, C.E. Hickman, Consideration of Energy Consumption in Desalination By Reverse Osmosis, Desalination 40 (1982), 259-270.
- 4 M.A. Darwish, I- On the Thermodynamics of Dual Purpose Power-Desalting Plants with Steam Turbines. Paper Presented in the 3rd World Congress, Cannes (1987).

TABLE 1\*  
Base Load Gas Turbine Data Conditions

Type	GE (1) LM 2500PE	ROLLS-ROYCE R-B 211 C	GE LM 5000 A	Westinghouse 501 - D	GE PG 7111E	BBC**
Shaft Output MW	22.01	25.36	32.47	103.47	77.35	51.4
Cycle efficiency % LHV	37.0	36.4	37.4	33.4	32.3	30.0
Cycle Pressure ratio	18.7	20.0	30.0	14.0	11.7	11
Air Flow Kg/s	66.9	89.0	120.2	323.3	274.4	216
Specific work KJ/kg air	328.9	285.2	270.3	284.7	281.9	238
Turbine Inlet temperature TIT, C	1212	1162	1156	1107	1104	1127
Exhaust Temperature C	513	475	425	521	538	525
Exhaust excess air percent	226	270	302	241	232	230

\* I.G. Rice, on discussion of : M.A.EL Masri "On Thermodynamics of Gas Turbine Cycles, Part II, Trans. ASME, Journal of Engineering for Gas Turbines and Power, Vol. 108, Jan. 1986, pp. 160 - 169.

\*\* Calculated

TABLE 2:  
Characteristics of Some Commercially Available Open Gas Turbine Cycles with Utilized Exhaust Gases for Process Heat or Combined Gas/Steam Turbines\*

Type	GE LM 5000	GE PG 6521	GE PG 7111	Westinghouse 501 - D.
Gas turbine power output, MW	32.67	35.86	75	101.41
Efficiency Percent, HHV	35.34	30.28	31.65	32.75
Exhaust gas temperature, C	425	549	540	521
Exhaust gas flow rate Kg/s	122.14	135.71	274.11	360.8
Available energy of exhaust gases, MW	19.87	31.64	62.24	77.32
Percent of exhaust gases availability to fuel availability %	21.4	26.7	26.27	24.97
Rankine Steam Power cycle output, MW	N/A	12.24	24.4	38.32
Combined Power Output per one gas turbine	N/A	48.10	99.30	139.73
Combined Cycle efficiency percent	N/A	40.62	41.9	45.13

\* Data taken from A.I. Kalina "Combined-Cycle Steam with Novel Bottoming Cycle" Trans. ASME., Journal of Engineering for Gas Turbines and Power, Vol. 106, Oct. 1984, pp. 737-742.



TABLE 3:  
Reference Combined Gas/Steam Plant with and without modifications  
for desalter combination

Gas Turbine				
Type of fuel	No. 2 oil			
Number	3			
Electrical output,	3 x 51.4	MW		
Rate of heat input,	526	MW		
Exhaust gas flow rate	3 x 216	Kg/s		
Exhaust temperature	526	C		
Thermal Efficiency	30%			

Boilers	Unfired	Supplementary fired*	
Number	3	3	
H.P. Steam Flow	3 x 26.3	3 x 45.8	
H.P. Steam Pressure, bar	43.2	43.2	
H.P. Steam Temperature, C	475	475	
Feed Water Temperature, C	120	120	
Exhaust Gas Turbine Temp., C	525	800	
Exhaust Gas Outlet Temp., C	155	155	
Supplementary heat $Q_s$ , MW	0	187.1	

Steam Turbines				
Type	Unfired		Supplementary fired	
	Condensing	Back Pressure*	Condensing	Back pressure*
Number	1	1	1	1
Electrical Output, MW	79	52.4	136.32	90.42
Exit Pressure, bar	0.076	2.1	.076	2.1
Cooling water requirement, Kg/s	345.0	none	6000	none
Process steam to desalter, Kg/s	none	78.9	none	137.4
Overall efficiency	44.3		40.74	-
Desalted water output, Kg/s (mgd)	0	693.3 (13.17)	-	1207 (22.86)
Mech. Energy loss/kg distillate, KJ/Kg	-	38.38	-	38.02

\* not included in the reference plant: values are calculated.

TABLE 4  
Desalted Water Output from Hybrid MSF/RO Desalting System and Back Pressure  
Steam Turbine (Scheme 3).

	MSF	RO Single Stage	RO Two Stage	Total
<b>(1) Unfired</b>				
Product Kg/s (mgd)	693.3 (13.17)	693.3 (13.17)	352.6 (6.68)	1739.2 (33)
Mechanical Power Consumption, MW	9.7	26.2	16.5	52.4
<b>(2) Supplementary Fired</b>				
Product Kg/s (mgd)	1207 (22.87)	1207 (22.87)	596.1 (11.29)	3010 (57)
Mechanical Energy Consumption	16.9	45.62	27.9	90.42

\* Mechanical power consumptions in MSF are calculated by assuming specific energy consumption for MSF equal 14 KJ/kg.

Table -5: Comparison of the Suggested Schemes Using the Reference 3 Gas Turbines Plant

Schemes	Equipment added turbine cycle.	Desalter Type	Power output water MW	Desalted water Kg/s(mgd)	Power to water ratio Kwh/ton.	Total heat input MW	Heat Charged to Power MW	Heat rate MJ/Kwh	Heat Charged to Desalter MW	Heat Sp. Fuel Energy Cons. KJ/kg
GT only	None	NA	154.2	NA	NA	526	-	12.28	NA	NA
Combined Cycle	HRSG, ST, CD, DR	NA	233.2	-	NA	526	-	8.12	NA	NA
Scheme I	HRSG, B. ST, DR	MSF	206.6	693.3(13.17)	82.8	526	466	8.12	60	86.5
	S. HRSG, B. ST, DR	MSF	244.6	1207(22.86)	56.3	713.1	600.4	8.836	112.7	93.4
Scheme II I	HRSG, B. ST, DR	MSF/RO	154.2	1739(33)	24.63	526	394.5	9.21	131.5	75.6
	S. HRSG, B. ST, DR	MSF/RO	154.2	3010(57)	14.23	713.1	394.5	9.21	318.6	105.8
Scheme IV	HRSG, DR	MSF	140.2	1000(18.30)	42.83	526	358.7	9.12	167.3	167.3
	S. HRSG DR	MSF	140.2	1660(31.40)	25.8	713.1	350	9.12	363.1	217.9
Scheme V	HRSG, B. ST, DR	MSF/RO	-	5034(95.38)	NA	526	-	-	526	104.5
	HRSG, DR			4188(79.3)						125.6

GT-gas turbine, ST - steam turbine, B. ST - back pressure steam turbine, HRSG - heat recovery steam generator (unfired), S. HRSG - supplementary fired HRSG, CD - condenser, DR - deaerator, RO - reverse osmosis.

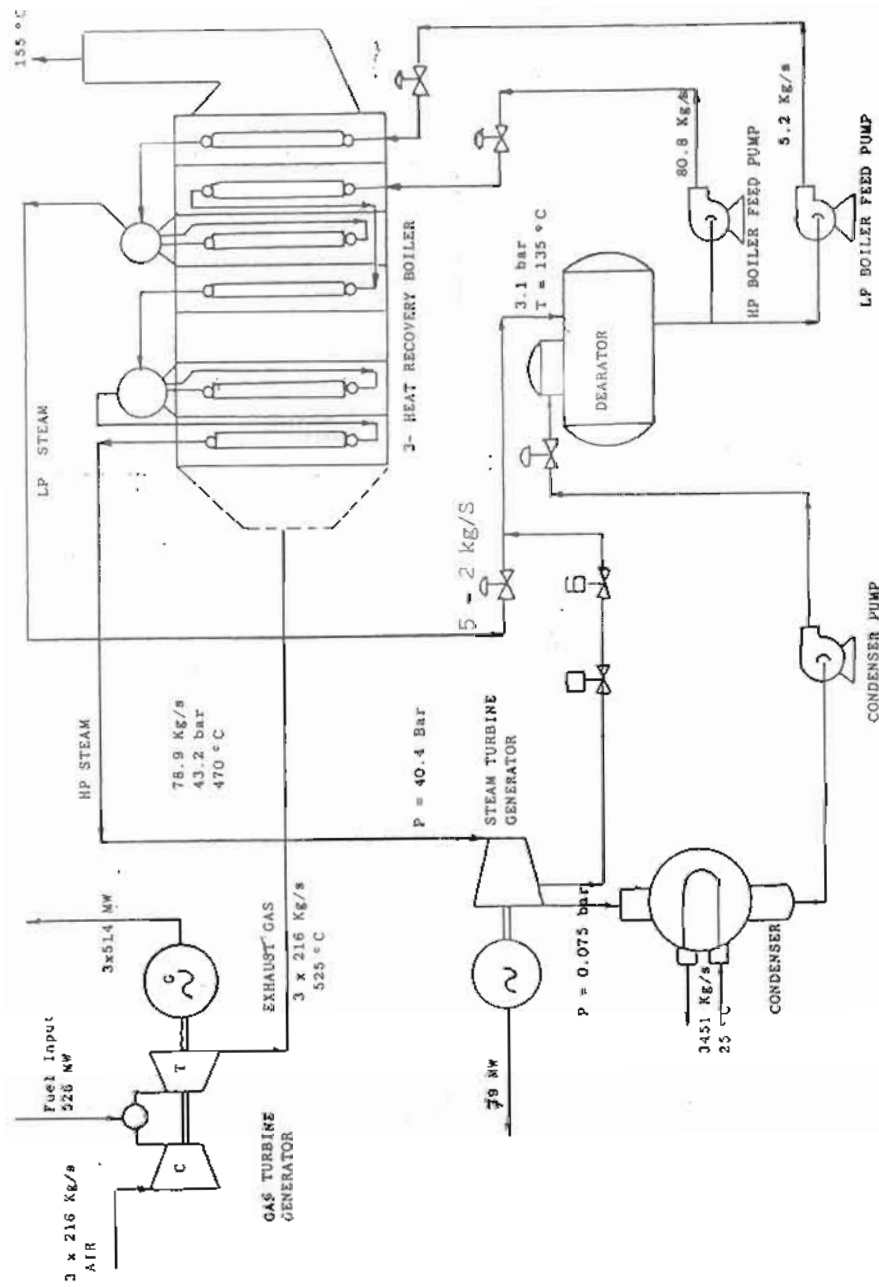

FIG. 1. REFERENCE COMBINED CYCLE GAS/STEAM TURBINE PLANT

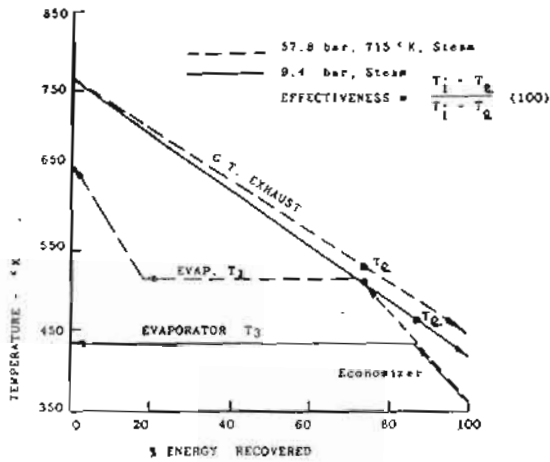

FIG. 2 (a). TEMPERATURE RELATIONSHIPS - UNFIRED HEAT RECOVERY BOILER

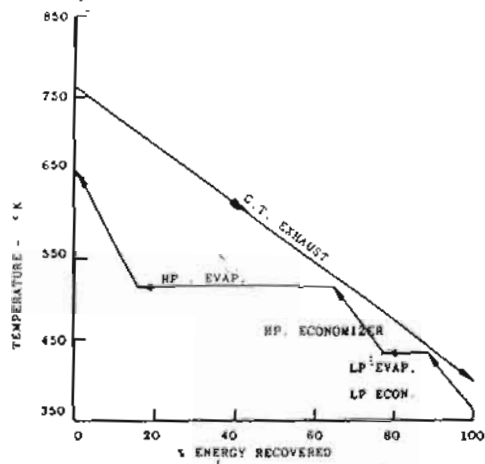

FIG. 2 (b) TEMPERATURE RELATIONSHIPS - TWO-PRESSURE LEVEL UNFIRED HEAT RECOVERY BOILER

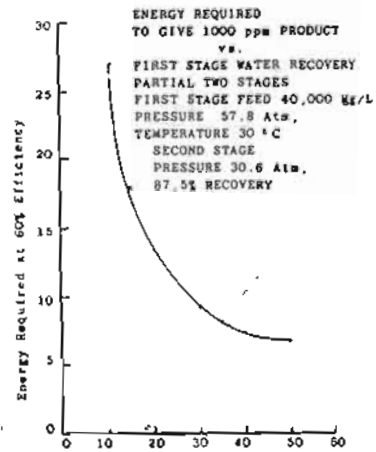
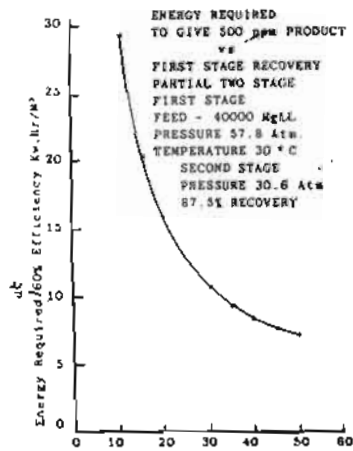

FIG. 3: ENERGY CONSUMPTION OF JEDDAH - NO PLANT. [ REF. 3 ]

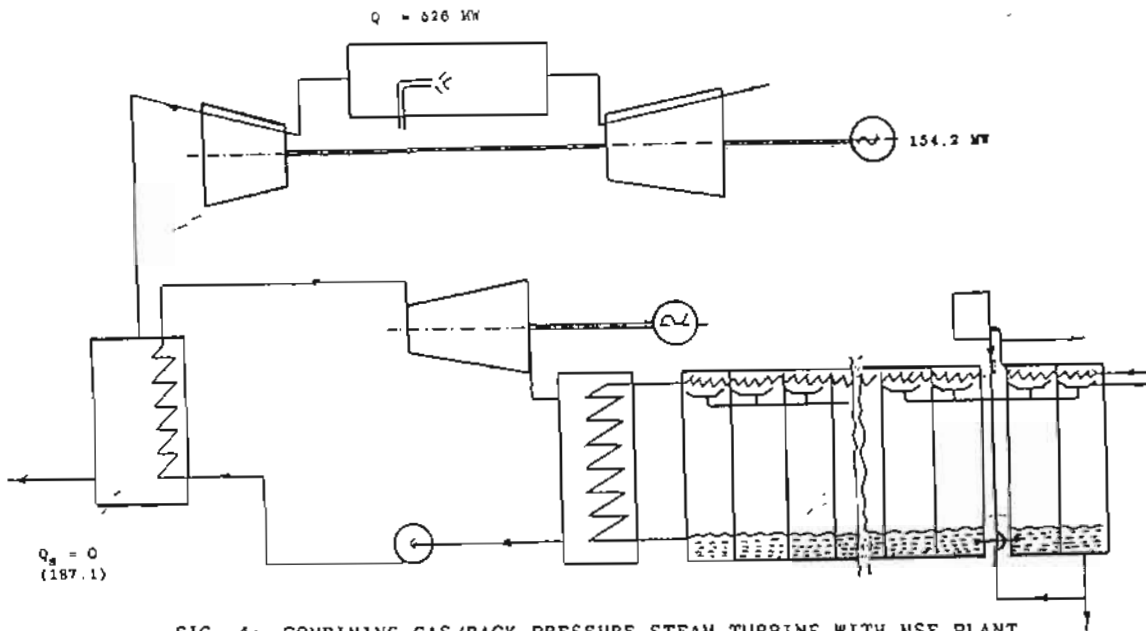

FIG. 4: COMBINING GAS/BACK PRESSURE STEAM TURBINE WITH MSF PLANT (Scheme I)

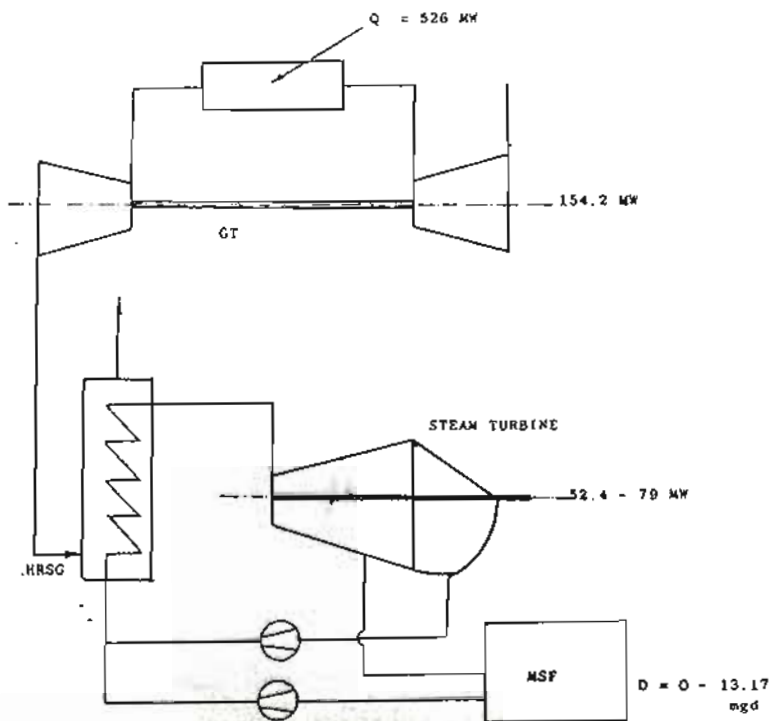

FIG. 5: COMBINED GAS/EXTRACTION-CONDENSING STEAM TURBINE WITH MSF (Scheme 2)

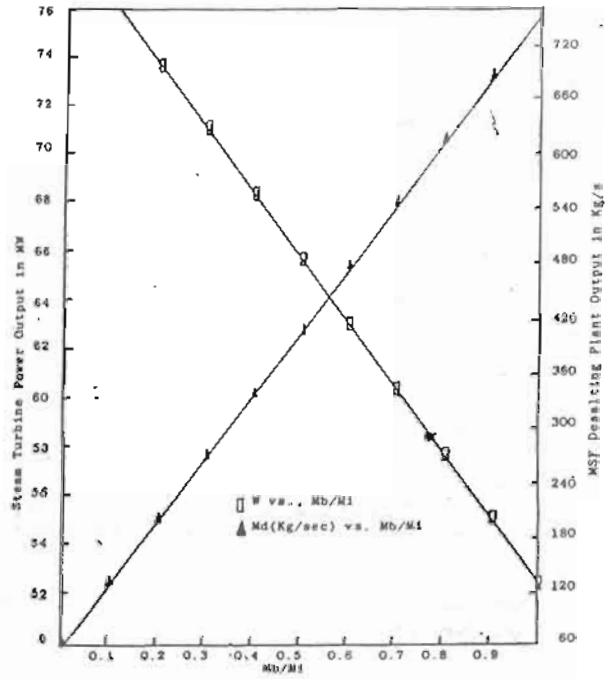

FIG. 6: THE EFFECT OF BLEEDING TO THROTTLING STEAM RATIO IN EXTRACTION-CONDENSING STEAM TURBINE ON THE STEAM TURBINE POWER OUTPUT AND AMOUNT OF DESALTED WATER.

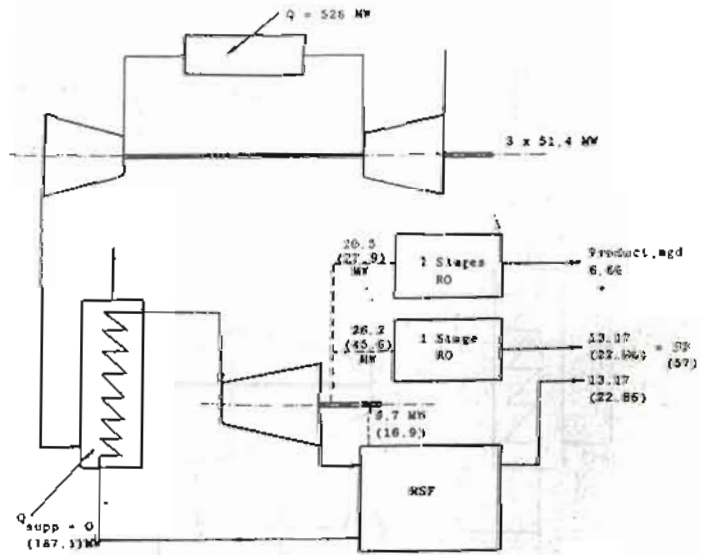

FIG. 7: COMBINING GAS/BACK PRESSURE STEAM TURBINE WITH HYBRID MSF/RO PLANTS (Scheme 15)

Values between brackets refer to supplementary fired HRSG.

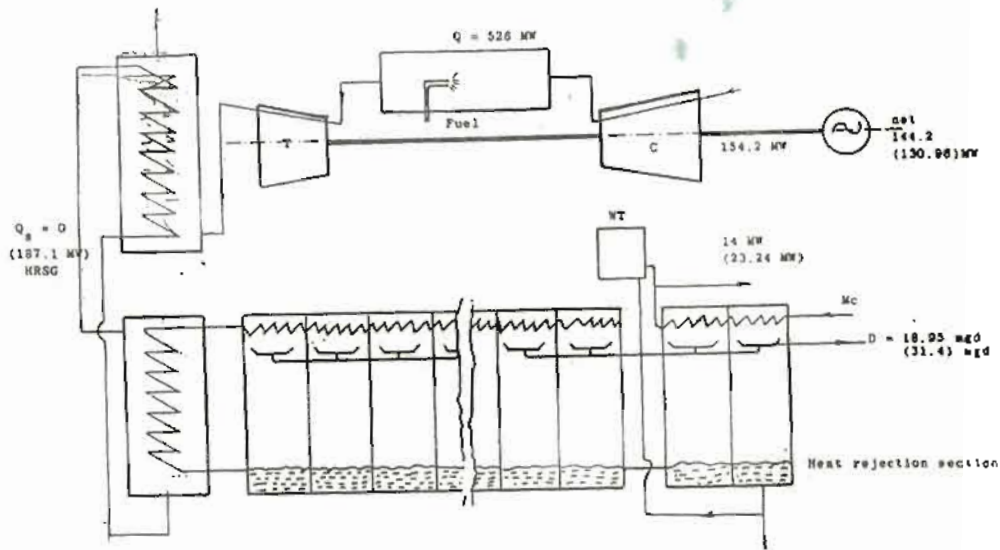
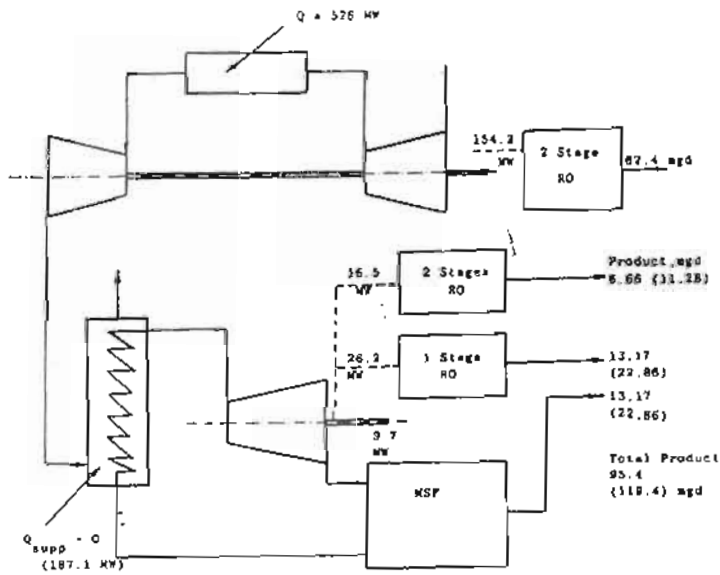

FIG. 8: COMBINING SIMPLE GAS TURBINE TO AN MSF PLANT (Scheme 4)



Values between brackets refer to supplementary fired HRSG

FIG. 9: ALL WATER PLANT (Scheme 5)